



SELECTRONIC



Instruction Manual for **SP LINK**

Configuration and monitoring for
SP PRO Series 2i



Contents

Contents	2	Generator Schedule Start	49
Using This Manual	3	Generator Control Settings	52
Overview	4	Solar Hybrid Control Settings	54
Using SP LINK	4	System Settings	57
System Requirements for SP LINK	5	Input and Output Settings	61
Firmware Version	5	Shunts Settings	68
Glossary of Terms	5	Expansion Card Wiring Diagram	69
SP PRO Fast Setup	6	Save and Configure Settings	69
Getting Started with SP LINK	7	Performance Monitoring	70
HELP!	7	Customer Interface	71
SP LINK Easy Start Guide	8	Integrator / User Interface	71
Site Configuration Wizard	9	Quick View	72
Select Battery Configuration	9	AC Coupled Low DC Recovery	74
Source of Renewables	10	Data View	75
Managed AC Coupled Solar Inverters.	10	Now Tab	75
Select Unit Application	11	STATUS	75
Extra Options	11	DC	76
Generator	12	AC Source	76
Generator Start / Stop	12	Inverter AC	76
Summary of Configuration	13	System regulation status	77
Entering extra Details and Saving	13	Today Tab	78
Connecting to the Inverter system	13	DC totals	78
Powerchain Inverter assignment	13	AC totals	78
Sending Configuration to the Inverter	13	DC Peak	78
Advanced Configuration	14	AC coupled SOLAR	78
Firmware Update (Easy Start Guide)	14	DC History Tab	79
Preparing a new site	15	AC History Tab	82
Saving a new site	16	Technical Data Tab	84
Manually Preparing a new configuration	17	Inverter Details Tab	87
Saving a new configuration	18	Battery Management Tab	88
Connecting to the SP PRO	18	Powerchain Tab	89
Connection status bar	19	Expansion Card Wiring Diagram Tab	90
Configuring the SP PRO	20	Service Settings	92
Connection Settings	21	Time and date	93
Powerchain Inverter Assignments tab	21	Battery SoC	93
Customising SP LINK to suit the site	24	Login Password	93
Performance Data Retrieval	25	Settings Passcode	93
Performance Data Viewer	26	Request Battery Equalise	94
Firmware Update	27	Setting Charge Efficiency Index	94
Configuration Settings	32	Zero Shunts	94
Quick Start	33	Fan Type	94
Inverter Settings	34	Expansion Card	94
Battery Settings	35	AC Solar Link Test	95
Charger Settings	37	AC Safety Monitor	95
AC Source Settings	40	Setting For Poor Grid Quality	95
AC Input	40	Schedule Restart	96
Power Quality / DRM	42	Installer Only Service Settings	96
Generator Auto Start	45	Appendix One Alert Messages	98



Using This Manual

While every attempt has been made to ensure this manual is as self explanatory and clear as possible, there are some technical issues and safety warnings that require thorough understanding. It is extremely important that you and your integrator/installer follow all of the instructions set out in this document; failure to do so may void the warranty and stop you from gaining the full benefits that we know this product can provide.

A PDF copy of this manual may be downloaded from the Selectronic web site www.selectronic.com.au and is also included within the Help menu of the SP LINK software.

You will notice that throughout the manual these symbols will be repeated. These symbols are very important.



This symbol indicates danger. Failure to observe this warning may result in serious injury or death, loss of property or damage to the power system.



This symbol is used to draw attention towards information that will assist you in making full use of the system or gives notice to information which may not seem immediately apparent.



Using SP LINK



Overview

“SP LINK is the pathway to the real power of the SP PRO”

SP PRO series of inverters are really many products in one. SP LINK provides a simple and easy way to configure your SP PRO to suit your particular installation.

Install SP LINK software (download from www.selectronic.com.au) onto a PC computer. We suggest these steps are done before heading to the installation site.

Once on site simply unpack the unit, mount it on a wall, connect the appropriate cables then use the Wizard in SP LINK to configure the SP PRO – and you’ve got power.



As a safeguard, the SP PRO inverters will not start until they have been configured using SP LINK.

System Requirements for SP LINK

The system requirements include:

PERFORMANCE REQUIREMENTS:

- Microsoft Windows XP SP3, Vista SP1, 7, 8, 8.1, 10
Other operating systems including IOS, Android and MAC not supported.
- 30 MB hard disk space
- If Microsoft .NET 4.0 Framework is not already installed then approx. 850 MB of additional disk space will be required.
- Adobe Reader - 100 MB hard disk space
- 1 GHz Pentium or faster processor.
- 512 MB RAM
- USB Port

PERFORMANCE VIEWER REQUIREMENTS

- Microsoft Excel 2003 or higher.
- Office 365 web versions not supported.

Firmware Version

This SP LINK manual details configuration parameters and options found in the included version of SP PRO firmware. Some parameters are no longer supported and are not detailed within this manual. Please refer to prior SP LINK manual for details of unsupported features.

SP LINK is fully backward compatible with all prior versions of SP PRO firmware.

Glossary of Terms

DC Coupled system	The PV Solar is connected to the DC side of the inverter system through a Solar Controller.
AC Coupled system	The PV Solar is connected to AC Side of the inverter system via a separate Grid Tie inverter.
Solar Hybrid	A system connected to the electricity grid and utilising batteries.
AC Source	The primary AC input to the SP PRO, e.g., Grid, Auto start Generator, Shore Power.
Site File	An SP LINK file which contains all the details needed for SP LINK to connect to that site.
Configuration File	An SP LINK file which contains all of the settings ready to save to the SP PRO
Solar Array	A collection of Solar Panels.
PV	Photo voltaic solar power .
Sealed Battery	A lead acid battery with no access to the electrolyte - either valve regulated or gel.
Flooded Battery	A lead acid battery with access caps for maintaining the electrolyte.
Lithium Battery	A battery based around lithium technology. An example is Lithium Iron Phosphate (LiFePO4)
Aquious Battery	A battery with salt electrolyte such as the Aquion brand of battery.
Managed Battery	A battery with a Battery Management System that communicates with the SP PRO via CAN bus.
Powerchain	An Advanced method of connecting multiple SP PRO inverters together in a tightly managed system. Example is twelve SP PRO inverters connected in a three phase configuration with four SP PRO inverters per phase.
System Manager	The primary inverter in a Powerchain configuration. This is always the manager on the L1 phase. The System Manager controls the operation, configuration and communications with all of the SP PRO inverters in the Powerchain system.
State of Charge	(SoC) is the amount of charge in the battery bank expressed as a % of the battery capacity. When SoC = 100% the battery is fully charged. When the SoC is 50% then the battery is half charged.

SP PRO Fast Setup

To quickly set your newly installed SP PRO and start producing power, follow the steps below.

STEP 1: Download the latest version of SP LINK from www.selectronic.com.au and install on your PC

STEP 2: Connect your SP PRO to the computer using the supplied USB cable.

STEP 3: Turn on the battery power to the SP PRO and wait 30 seconds for the front LEDs to light up.

STEP 4: Start SP LINK on your Computer.

STEP 5: Select “Firmware Update” being the forth entry in the easy start guide. Follow instructions to update the SP PRO firmware.

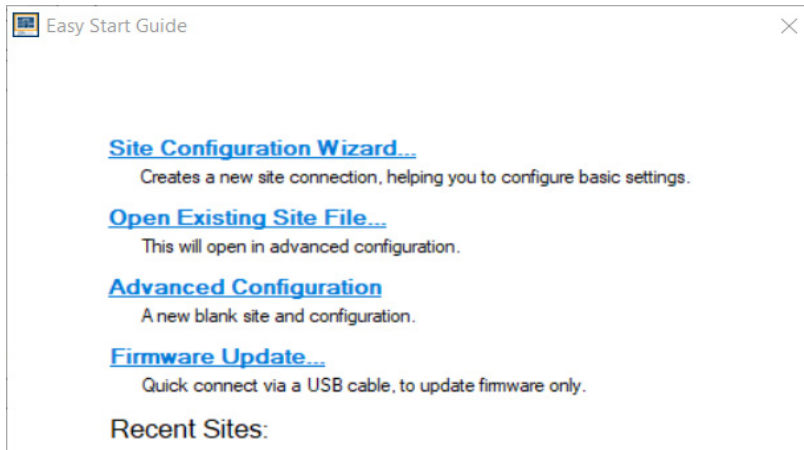

STEP 6: Return to the easy start guide and select “Site Configuration Wizard” being the first entry.

STEP 6: Follow the steps in the Site Configuration Wizard to create a configuration for the SP PRO.

STEP 7: Review the Summary of Settings screen to ensure your newly created configuration details are correct.

STEP 8: When the wizard is complete you will be at the Connection Settings tab. Click Connect.

STEP 9: You will be prompted to save your newly configured site and configuration. Once this is done SP LINK will connect to your inverter.

STEP 10: Click “Configuration Settings” Tab

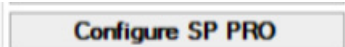
STEP 6: Click  button and enter Settings passcode 74 when prompted.

See the next section for more detailed setup information.

Getting Started with SP LINK

You will find the latest version of SP LINK and other helpful documents on the Selectronic Web site found at www.selectronic.com.au. It is good practise to check for the latest version of SP LINK before going to site.

After loading SP LINK onto the computer, you can now begin to use SP LINK. However, we do warn that to achieve the best performance from the system, configuration should be done by an experienced system designer. For maximum warranty in Australia, you will need to employ the services of a qualified system Integrator. For full warranty terms and conditions please see the warranty supplied with the SP PRO inverter.

To get started, you do not have to be connected to an SP PRO inverter. Once you have loaded SP LINK onto the computer, you can pre-configure and store on the computer the site information and configuration settings. These are then ready to transfer into the SP PRO inverter after it is installed.



When you first open SP LINK, the Splash screen will appear. Once SP LINK has loaded, the screen will disappear and the “How to Access Help” screen will appear.

HELP!



When working with SP LINK simply RIGHT CLICK MOST HEADINGS and tabs and a help panel will appear on the right side of the screen.

You will see the How to Access this Help guide each time you start SP LINK

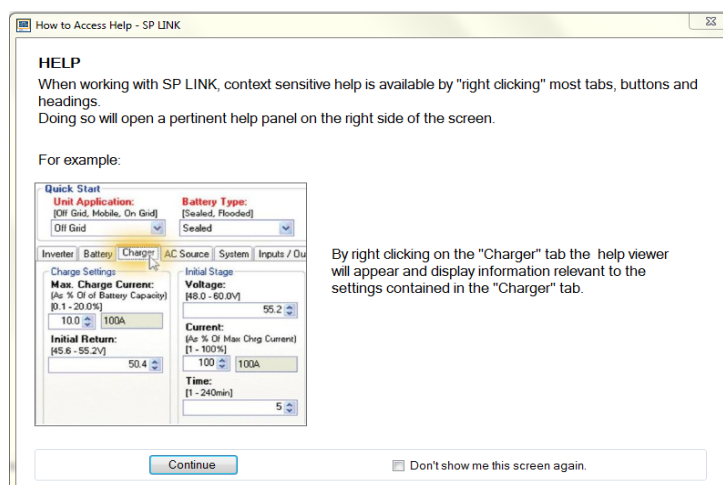

By clicking “Continue” SP LINK Easy Start Guide will start. By clicking the tick box “Don’t show me this screen again” will prevent this from being displayed in the future.

You can also access both the SP PRO manual and SP LINK manual (this document) from the Help menu at any time.

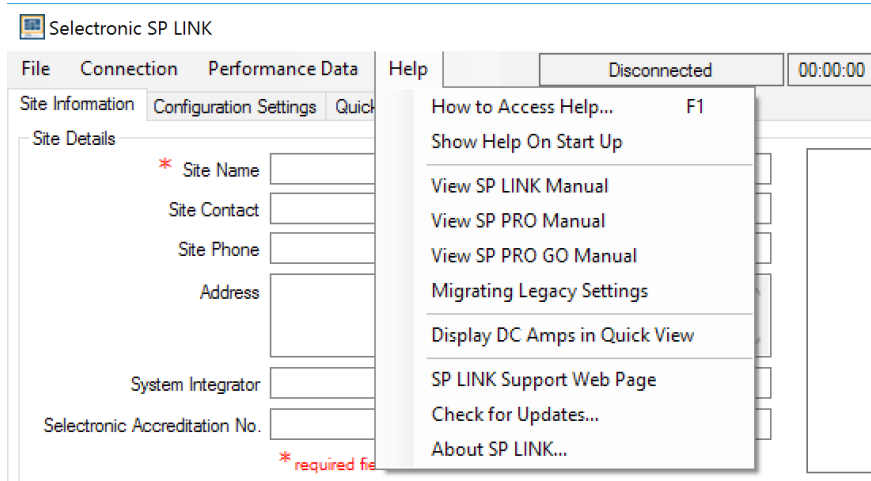

SP LINK Easy Start Guide

The Easy Start Guide provides a quick means of performing the most common tasks in SP LINK. Simply choose one of the three options or select from Recent Sites to open the saved information on an already configured SP PRO

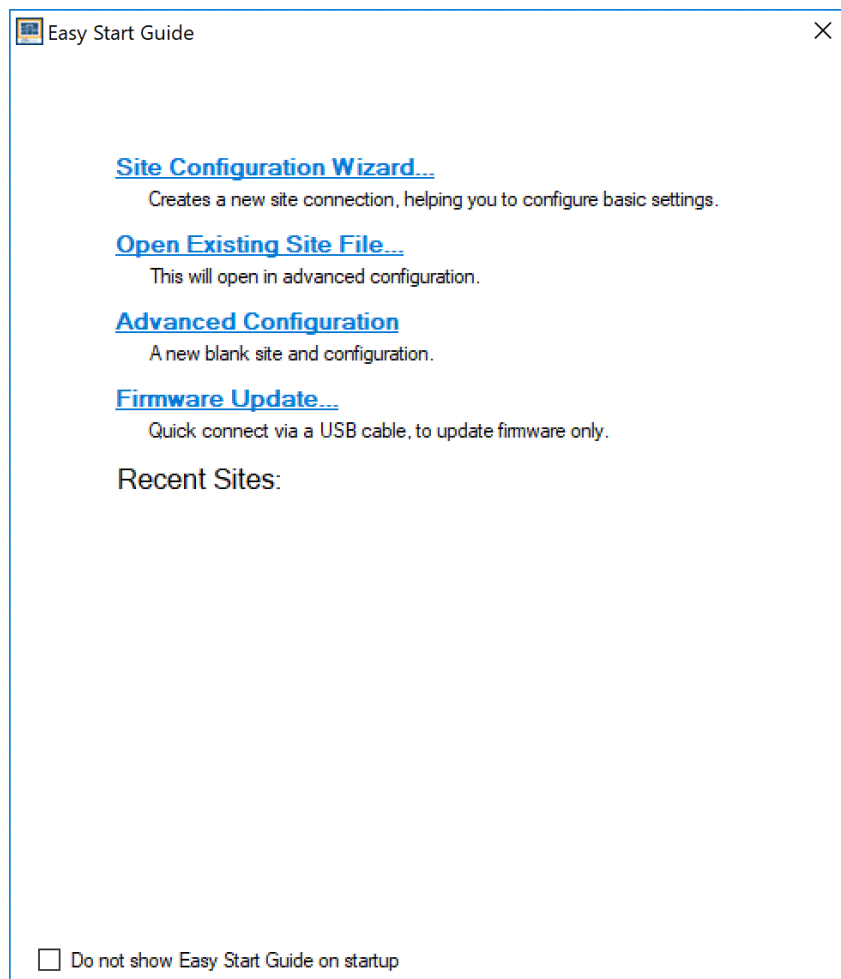

This window appears every time SP LINK is started and can also be accessed at any time via the “File / Site Information / New (Easy Start Guide)” menu (or Ctrl N short cut).

Site Configuration Wizard

Provides a quick and easy way to configure a SP PRO in a new installation. The configuration information can be created and saved to a Site file ready for sending to the inverter as required.

The wizard steps through the configuration process and informs the system designer at each step of any invalid configuration or limitations of the chosen components.



The Site configuration wizard a powerful system validation tool. Just enter your proposed system details and the wizard will validate your design at each step.

The wizard is self explanatory. A description of each screen is given below

New Site Configuration Details

Enter a unique and descriptive name for the site where the SP PRO is installed. This name will be used to store and retrieve the information at a later date.

Single Inverter / Powerchain System. Select the system Configuration, Single Inverter or Powerchain system (Three phase, Split phase or multi inverter single phase).

Inverters per phase: Enter the number of SP PROs that are connected to each phase. For example in a three phase configuration with 6 SP PROs, there will be 2 inverters per phase. In a single phase configuration with 3 inverters there will be 3 inverters per phase.

Select a Detected USB Device: If the computer USB port is plugged into a powered up SP PRO then its model number and serial number will be displayed. Select this option.

Manual Configuration: If there is no SP PRO connected then select the SP PRO model number.

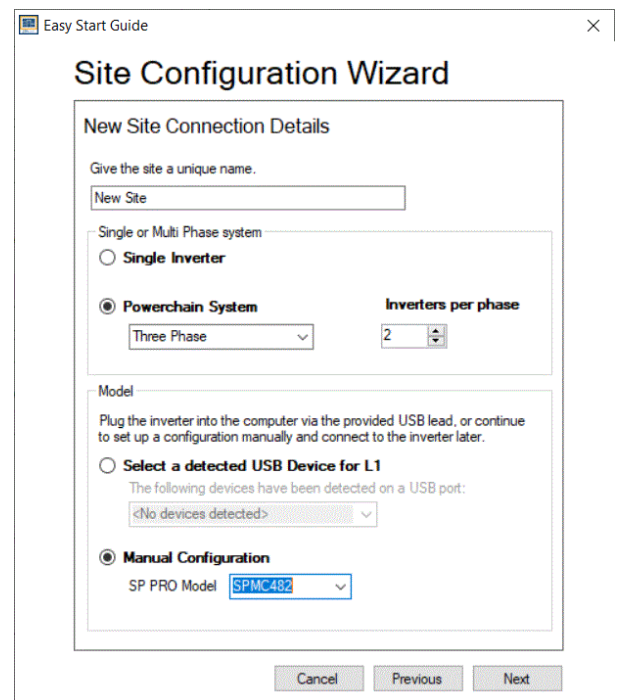

Select Battery Configuration

Standard Battery Configurations and myGrid Kits offers choices of myGrid kits and other specific battery configurations, such as LG Chem.

Otherwise select **Custom Battery Configuration** to manually enter the battery information.

Once the battery type is chosen the battery State of Charge levels are chosen (except for No Battery option).

SoC Support Limit (Support Capacity) sets the energy that is available for normal daily operation. If the system is Off Grid with an auto start generator, then this is the SoC level at which the generator will start This value is dependant on the battery type and its expected cycle life.

Inverter Shutdown SoC (Minimum Backup Capacity) sets the energy available during either a grid outage (for Solar Hybrid) or when the generator fails to start (for off grid).

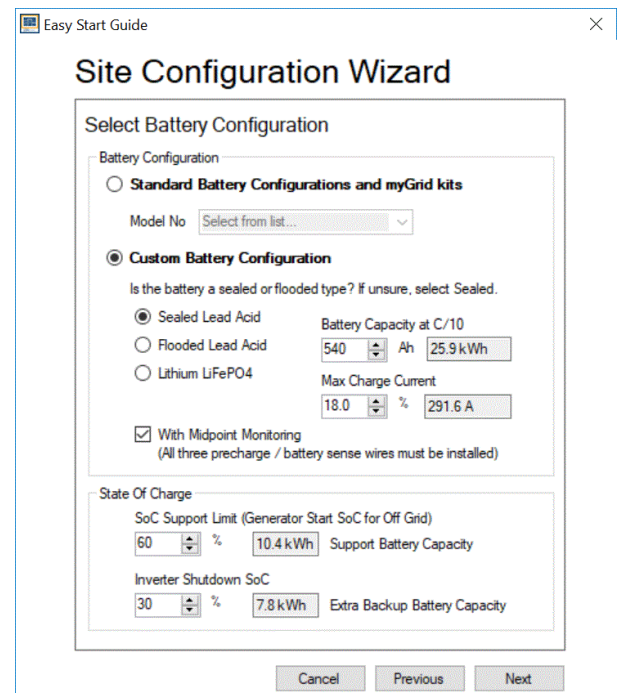

Source of Renewables

Select the configuration of the Solar or other renewable energy sources in the system. The wizard will ask you for more information on the next screen.

If the energy source is **DC coupled** (that is fed into the battery via a DC charge regulator or DC MPPT) then an external DC current shunt must be installed.



Easy Start Guide

Site Configuration Wizard

Source of Renewables

Managed AC Coupled Solar Inverters
Details will be entered in the next step.

Generic AC Coupled Solar (Solar Hybrid only)

DC Coupled
DC Shunt Current: 200 Amps
DC Shunt Voltage: 75 mV

No Renewables

Cancel Previous Next

Managed AC Coupled Solar Inverters.

This screen is displayed when **Managed AC Coupled Solar** is selected on the previous screen. The Selectronic Certified or Select Sun grid inverter is selected.

Grid Inverter number of phases. Select the type of grid inverter to be installed. Only the Fronius or Select Sun three phase grid inverters can be installed and only on a three phase SP PRO configuration

Grid Inverters per phase. The number of grid inverters connected to each of the phases in a Powerchain three phase or split-phase system. For a single phase system enter the number of grid inverters connected to L1.

Whilst the SP PRO is connected to grid power, the maximum allowable Managed AC coupled solar power is only limited by the selected SP PRO model.

When the SP PRO is running Islanded (either the grid has failed or the system is an Off Grid system), the SP PRO will limit the maximum solar power that can be produced by the Selectronic Certified or Select Sun grid inverters. This limit is determined by the system battery capacity as displayed on the screen.



Easy Start Guide

Site Configuration Wizard

Managed AC Coupled Solar Inverters

Grid Inverter Family

ABB Solar
ABB Model Series:
 PVI
 UNO DM-TL (PLUS / Q)

Fronius

KACO Powador
KACO Year of Manufacture:
 2013 and earlier
 2014 and later

Select Sun

Grid Inverter number of phases

Single Phase
 Three Phase
Note: Three phase grid inverters must be managed on the L1 phase.

Grid Inverters per phase

L1: 1
L2: 0
L3: 0
Split: 0

On Grid, the total rated AC power output of the ABB Solar inverters must not exceed 15 kW.

Cancel Previous Next

Select Unit Application

The first three options are for grid connected systems only (Solar Hybrid). The **Off Grid** Option is only applicable when no grid is available.

When **Self-Consumption of Renewables** is chosen in a system with Lead-Acid batteries, the system will do a full recharge once per week. The time can be changed to coincide with the period of lowest tariff and at a time when the renewable would have performed a full charge when available.

A full recharge is not required for lithium batteries.

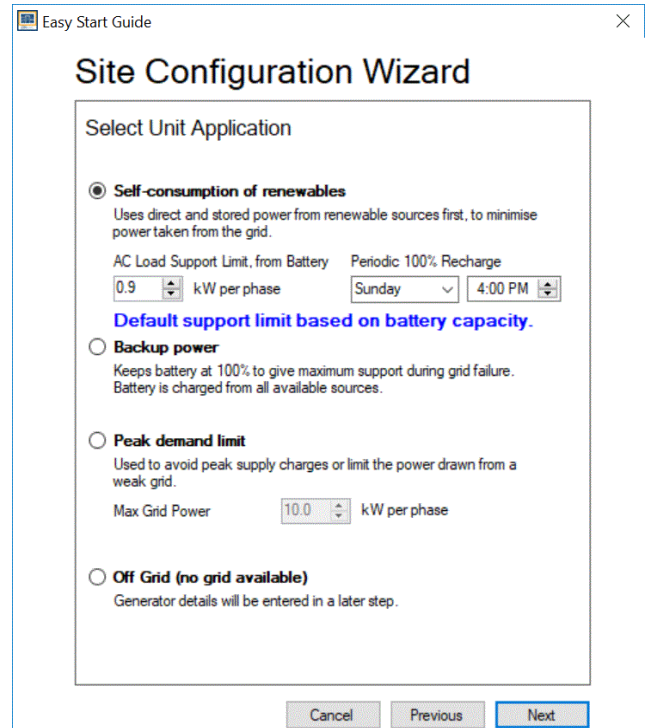

Easy Start Guide

Site Configuration Wizard

Select Unit Application

- Self-consumption of renewables**
Uses direct and stored power from renewable sources first, to minimise power taken from the grid.
AC Load Support Limit, from Battery: 0.9 kW per phase
Periodic 100% Recharge: Sunday 4:00 PM
Default support limit based on battery capacity.
- Backup power**
Keeps battery at 100% to give maximum support during grid failure. Battery is charged from all available sources.
- Peak demand limit**
Used to avoid peak supply charges or limit the power drawn from a weak grid.
Max Grid Power: 10.0 kW per phase
- Off Grid (no grid available)**
Generator details will be entered in a later step.

Cancel Previous Next

Extra Options

If you are using an **External AC Source contactor** and current transformers then enter it here.

Where a **Grid Fail Generator Backup kit** is installed then select this option.



PLEASE NOTE: For a three phase Powerchain system, three Grid Fail Generator Backup kits are installed. One in each SP PRO phase manager.

Set the **AC Source Limit** to match the capacity of the AC Source connected to the SP PRO.

Max Grid Input Power. The SP PRO will attempt to keep the power that is taken from the AC Source below this limit by supporting any excess load power from the battery bank.

Max Grid Export Power. The SP PRO will limit the power that is exported to the AC Source below this value by limiting the power produced by managed AC coupled solar or DC coupled solar.

Generic AC coupled solar cannot be export limited by the SP PRO.

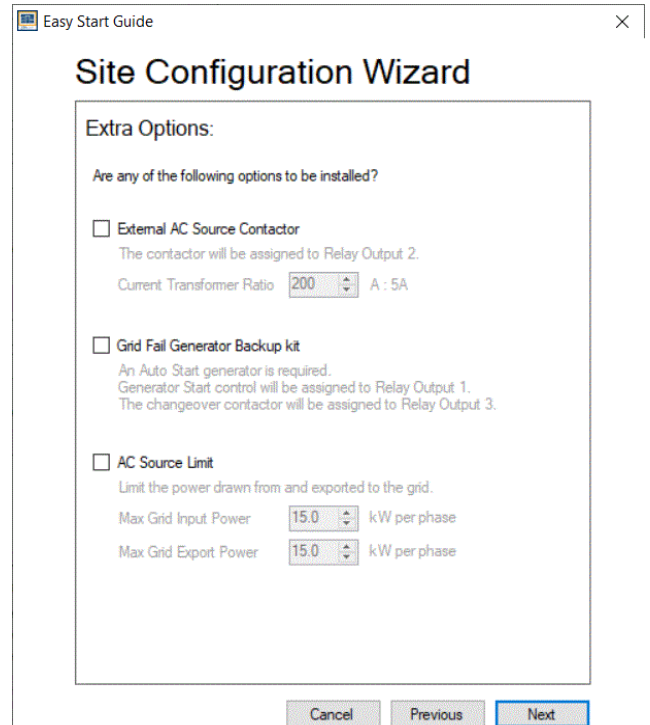

Easy Start Guide

Site Configuration Wizard

Extra Options:

Are any of the following options to be installed?

- External AC Source Contactor**
The contactor will be assigned to Relay Output 2.
Current Transformer Ratio: 200 A : 5A
- Grid Fail Generator Backup kit**
An Auto Start generator is required.
Generator Start control will be assigned to Relay Output 1.
The changeover contactor will be assigned to Relay Output 3.
- AC Source Limit**
Limit the power drawn from and exported to the grid.
Max Grid Input Power: 15.0 kW per phase
Max Grid Export Power: 15.0 kW per phase

Cancel Previous Next

Generator

This screen will be displayed if the system is either an Off Grid System or it is a Solar Hybrid system with Grid fail Generator Backup module installed.

Where either an **Auto Start** or **Manual Start** generator is selected then enter the **Generator Size**.

Solar Backoff Generator Minimum Power sets the minimum power that the SP PRO will attempt to draw from the generator. It does this by backing off any managed AC coupled solar when the generator power drops to this level.



PLEASE NOTE: Whilst the Site Configuration Wizard allows for no generator in an Off Grid System, it is highly recommended that the system is installed with a generator. To take full advantage of the SP PROs advanced generator control functions, an auto start generator is recommended.

When a Grid fail Generator Backup module is installed in a Solar Hybrid system, an auto start generator must be installed.



Easy Start Guide

Site Configuration Wizard

Generator:

Will this system have a generator attached?

No Generator
 Auto Start
 Manual Start

Generator Size: 42.0 kVA, Three Phase

For the SPMC482 in three phase, the suggested generator size is around 42 kVA.

The generator may have a minimum load power requirement to regulate its output correctly. Generator load power will not be reduced below this level by Managed AC Coupled Solar.

Solar Backoff Generator Minimum Power: 0.0 kW per phase

Cancel Previous Next

Generator Start / Stop

This screen is displayed where an Auto Start generator is installed.

Use this screen to set the basic generator control functions as required.

Enable Generator Lockout. Check this box if you wish to have a period of time each day to prevent a generator start, such as over night.

Obviously if the battery SoC or voltage reaches a critical point then you would want the generator to start during this period anyway. Enter the values for SoC and battery voltage that is deemed critical.

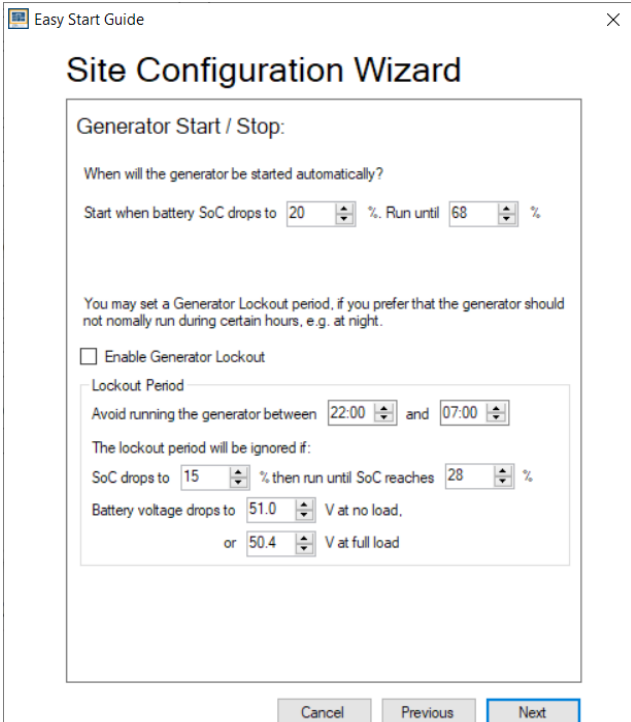

Easy Start Guide

Site Configuration Wizard

Generator Start / Stop:

When will the generator be started automatically?

Start when battery SoC drops to 20 % Run until 68 %

You may set a Generator Lockout period, if you prefer that the generator should not normally run during certain hours, e.g. at night.

Enable Generator Lockout

Lockout Period

Avoid running the generator between 22:00 and 07:00

The lockout period will be ignored if:

SoC drops to 15 % then run until SoC reaches 28 %

Battery voltage drops to 51.0 V at no load,
or 50.4 V at full load

Cancel Previous Next

Summary of Configuration

This screen gives a summary of all the settings entered in the previous screens.

Please check this screen carefully before proceeding.

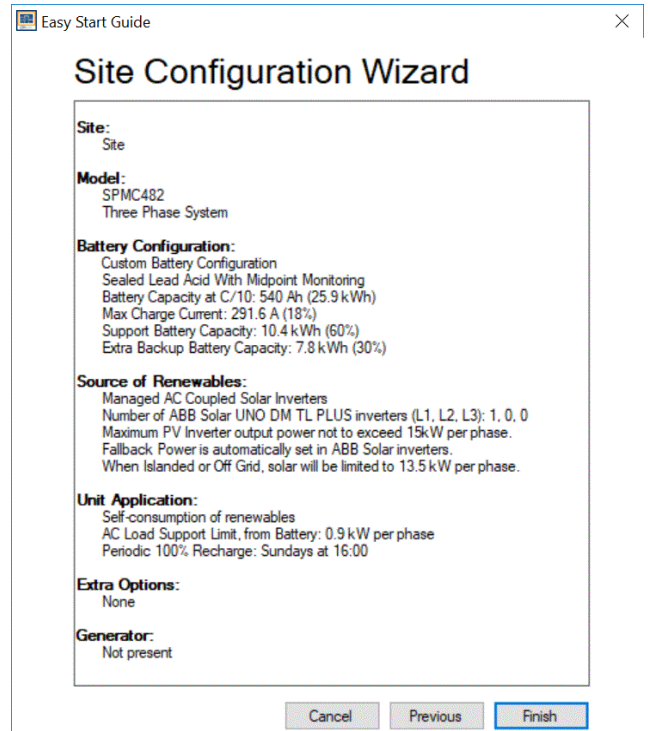

Entering extra Details and Saving

Any further site information and connection settings may now be entered. If any of the advanced settings need configuring then this should also be done now. Once all the information has been entered and the configuration is complete the Site file along with the Configuration details can be saved to file using the File/Site Information/Save menu (or hit CTRL S key).

Connecting to the Inverter system

Plug the computer into the inverter or the System Manager in a Powerchain system using the supplied USB lead then click the Connect button in the Connection Settings.

Powerchain Inverter assignment

If the system is a Powerchain then you will be taken to the Powerchain Inverter assignment tab. Follow instructions in the tab to assign all the inverters in the Powerchain system.

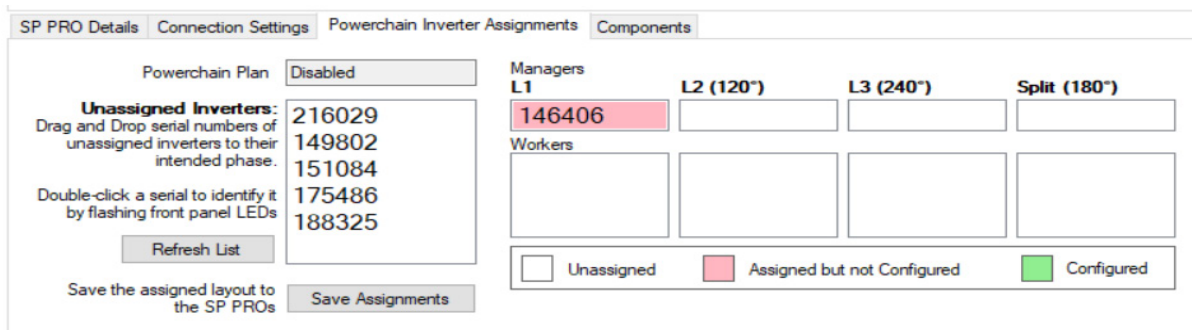

Sending Configuration to the Inverter

The configuration is now ready to transfer to the SP PRO. Select the Configuration Settings tab and click the "Configure SP PRO" button.

Enter the Settings Passcode 74 when prompted.

See [Saving a New Site](#) and [Connection Settings](#) sections for more information.

Advanced Configuration

Advanced configuration gives access to all the functions of the SP PRO allowing the installer to create a Site file and manual configuration that starts with either the default settings or settings created from the Site Configuration Wizard.

The Quick View and Data View tabs read all the information from the connected SP PRO to assist the installer in commissioning and diagnosing the System.

Please remember that if help is require for a function in the SP PRO hover the cursor over the heading or right click on the heading to be taken to the relevant section of the SP LINK manual.

Firmware Update (Easy Start Guide)

The Firmware Update option in the Easy Start Guide is a quick and easy way to update the firmware in the SP PRO without the need to set up a site file. This option is normally used to update firmware before configuring a new system. If the firmware is to be updated in an existing system then refer to Firmware Update page 27

The SP PRO must be connected to the computer running SP LINK via a USB cable or an ATEN or Belkin USB to serial adaptor.



All the SP PROs in a Powerchain system can be updated together. Make sure the SYNC cables are connected between all the SP PROs and they have DC battery volts supplied. Connect the USB lead to the System manager (L1 Manager) then follow the instructions below.

When this option is selected, the **Easy Start Guide, Firmware Update** window is displayed.

Select USB Device - If there is more than one SP PRO plugged into the computer, then select the one you wish to update.

Connect and update firmware: If the SP PRO has the default User Access Password then just click Connect.

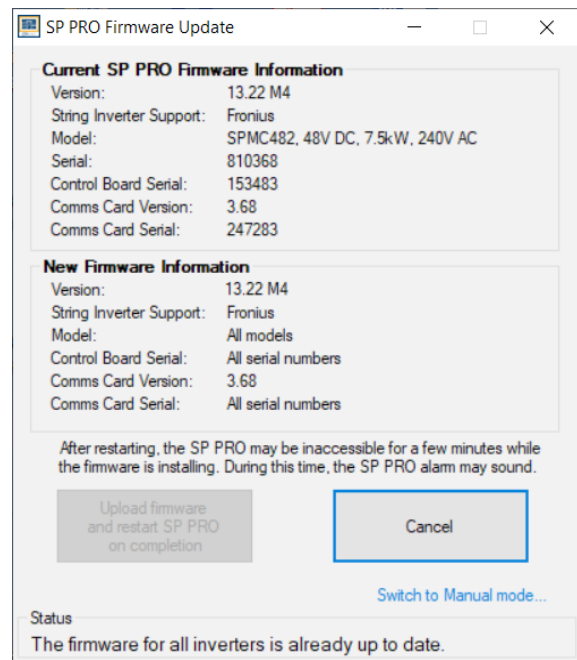
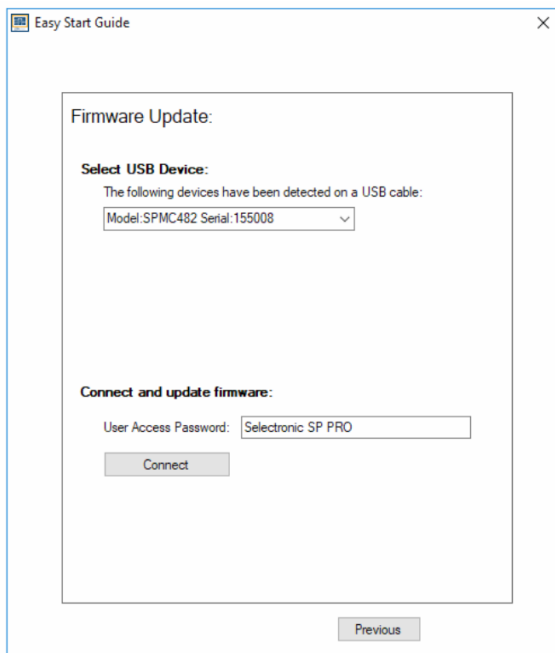

Otherwise enter the User Access Password before connecting.

Once SP LINK connects to the SP PRO, the **SP PRO Firmware Update** window will appear. Select "Update Firmware and Restart SP PRO on Completion". If this option is disabled then the firmware is up to date.

When the firmware update process is complete, the **Easy Start Guide, Firmware Update** window appears to allow other SP PRO inverters to be updated. When finished select Previous to go back to the Easy Start Guide.

Preparing a new site

SP LINK Advanced Configuration will open in the Site Information tab. Information must be entered in the mandatory fields with red stars including information in the lower tabs. Also it is not possible to proceed without setting up and saving the site information into a Site file.

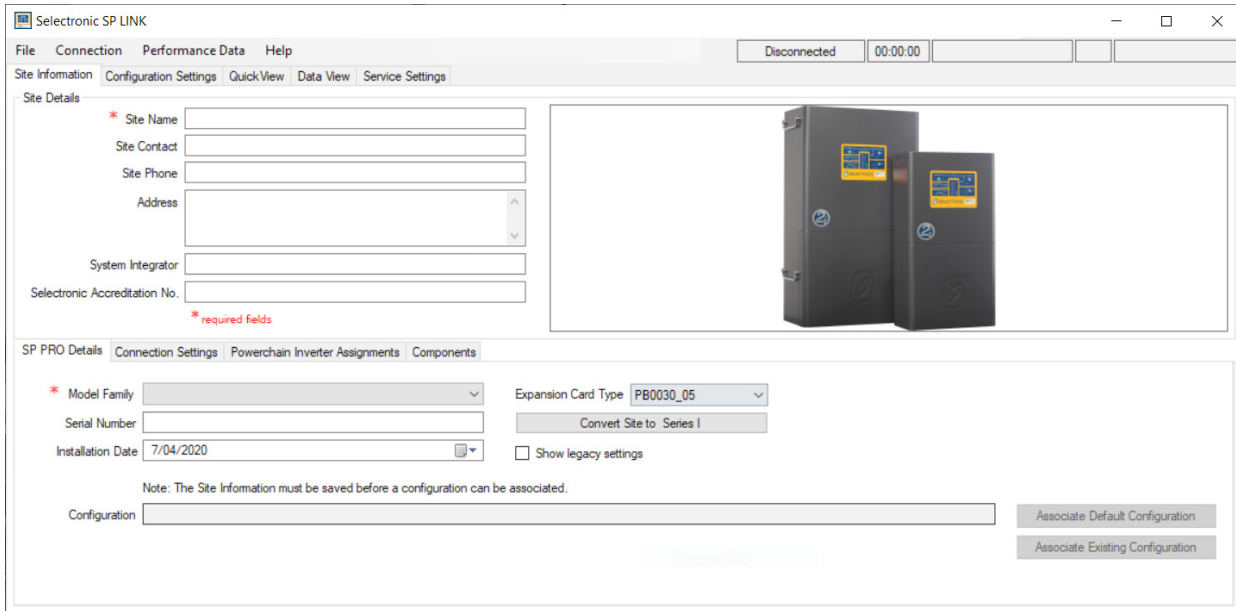

There is a large window on the right side of the Site Information page, click here to place a photo of the system
 To create a new site file for Series I units, click on Convert to Series I and then proceed with remaining steps.
 For backward compatibility for SP PRO firmware version prior to 7.0, tick Show legacy settings option. SP LINK will also automatically detect this upon connection to a SP PRO unit with firmware prior to 7.0.
 It is also helpful to place photos of the various system components under the Components tab.

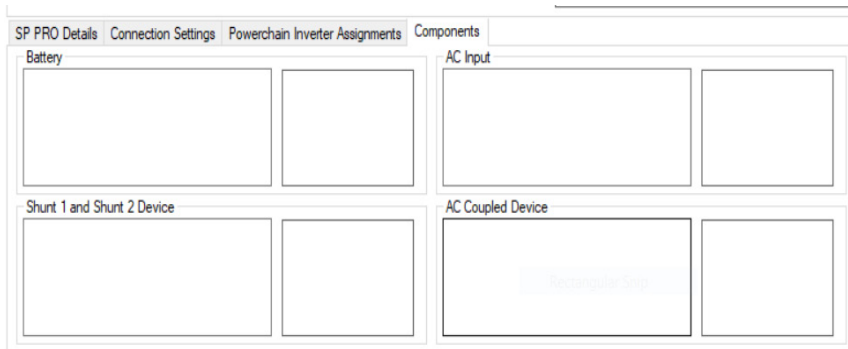

Under Connection Settings please select the Connection Type method to connect to the SP PRO. To connect directly to the USB port of the SP PRO select USB. The model number/serial number of the SP PRO to be connected to can now be selected from the list

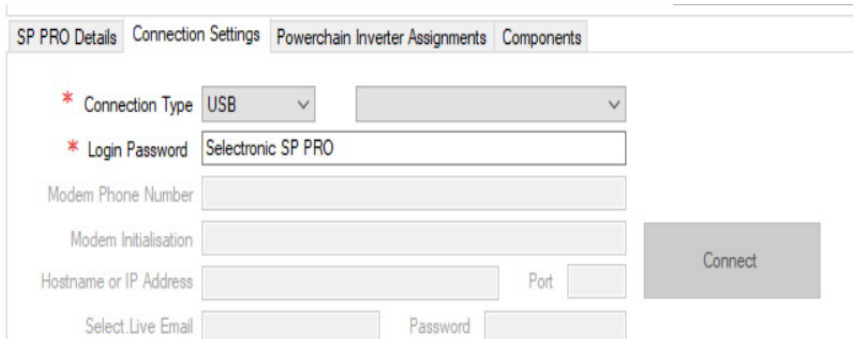

A LOGIN PASSWORD is required for connecting to the SP PRO. SP LINK can only connect with the correct password. The default password is “Selectronic SP PRO”. The Login Password is different to the Setting Passcode.

The LOGIN PASSWORD only needs to be changed if you wish to prevent any connection to the SP PRO. This is particularly important to secure the SP PRO against unauthorised monitoring or modification when the SP PRO is remotely accessible via a Modem or Network connection type. Once connected, the default password may be changed under Service Settings. If the Login Password is lost or forgotten it can only be reset by a procedure that requires someone to be on site. Contact an Accredited Integrator.

Saving a new site

All site information must now be saved.

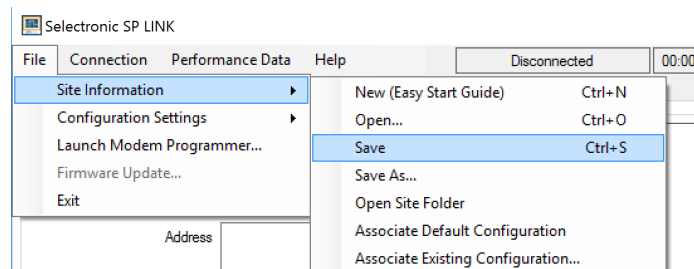

To save the SP PRO site information, click on File - Site Information - Save.

As this is a new site you will need to chose a common place on the computer to store the site folder, other information about this site such as Performance Downloads and Configuration settings will automatically be placed in this folder, the folder will have the same name as the site. Site files will be named with a .SPLS extension.

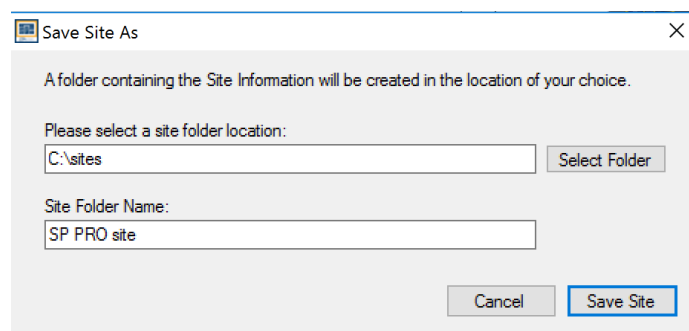

Manually Preparing a new configuration

You can now start to prepare a manual configuration. The SP PRO configuration is stored in a file within the site file and contains all of the SP PRO settings for transferring into the SP PRO when connecting via SP LINK.

Click on the Configuration settings tab.

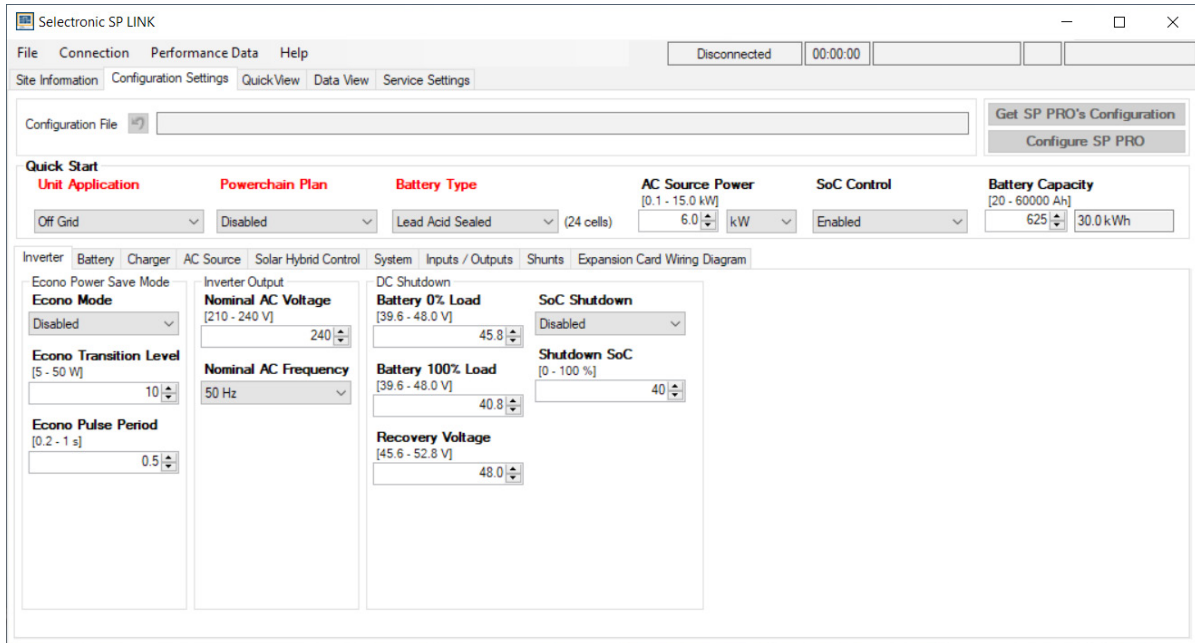

The SP PRO is a very advanced and intelligent product but don't let the large number of settings concern you.



Use the Site Configuration Wizard to set up the standard configurations before setting any advanced functions.

There is a Quick Start section near the top of the page which contains the settings that need to be considered for all applications.

Saving a new configuration

The configuration settings should now be saved to file before sending them to the SP PRO.

To save the SP PRO configuration settings, click on File - Configuration Settings - Save.

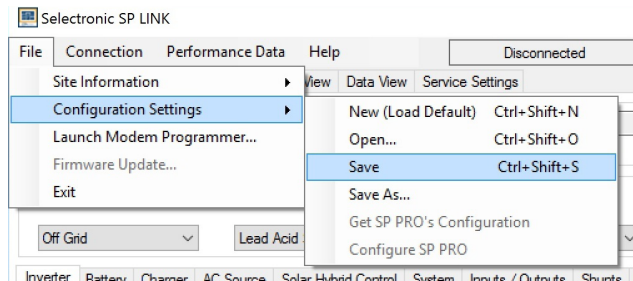

The configuration settings will be saved in the same location as the site information saved in the previous step. SP LINK will automatically use the default file name Config1 prefixed with the site name.

The configuration settings are now stored on the computer. The SP PRO can be configured with these settings at any time once the computer is linked and connected to the SP PRO.

Connecting to the SP PRO

Plug the SP PRO into the computer with the supplied USB cable. The SP PRO will be automatically detected by the computer and SP LINK. When this occurs it will be indicated by SP LINK showing both model and serial number under Connection Settings.

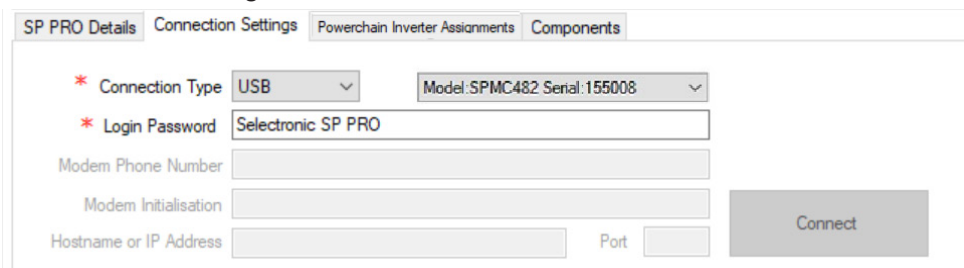

Now we can connect to the SP PRO. Either clicking the Connect button or in the Connection menu, click Connect.

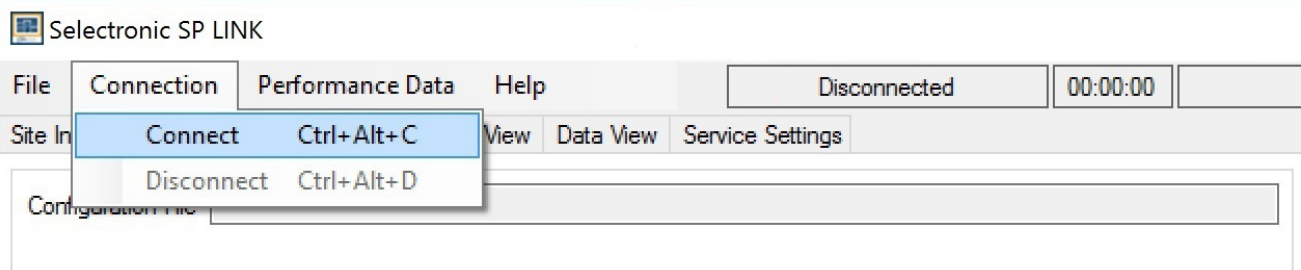

SP LINK is now connected through to the SP PRO. SP LINK will notify you if a connection is unable to be established.



It is important to note that the SP PRO has NOT yet been configured with any of the setting changes made at this time. This is performed in the next step.

SP LINK will notify you if the connected SP PRO does NOT have the same model number and serial number as detailed in the SP LINK “SP PRO Details” tab. SP LINK will also prompt you, as required, to update the time within the SP PRO from the computers time.

Connection status bar

The connection status bar appears in the top right of the screen in SP LINK and is always visible. It is divided into 5 sections as listed below:

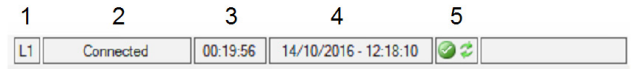

1 - In a three phase or split-phase Powerchain system, designates the phase to which you are connected. This is blank in a single phase system.

2- Connected: SP LINK is connected to the SP PRO. Configuration settings, firmware updates, Performance downloads and Live data readings are available.

Disconnected: SP LINK is not connected to the SP PRO

Busy: SP LINK is busy doing a download or firmware update to the SP PRO

3. The duration in hh:mm:ss that this session of SP LINK has been connected to the SP PRO.

4. The Date and Time of Day within the SP PRO

5. The Status of the AC input of the SP PRO.

The left hand icon is the “AC Source Status” which is green tick when the grid is in tolerance and red when the grid is out of tolerance according to the settings in Configuration Setting > AC Source > AC Input menu.

The right hand icon is the “Output Mode” of the SP PRO inverter. This is red when the SP PRO output is off, green tick when the output is on and in stand alone, and green arrows when the output is in sync and connected to the AC Source input.

Five examples of Connection Status bar are shown, summarised as follows:

	1	2	3	4	5
A	L1	Connected	00:19:56	14/10/2016 - 12:18:10	
B	L2	Connected	00:10:18	14/10/2016 - 12:08:32	
C		Connected	00:23:52	14/10/2016 - 12:22:06	
D		Connected	00:21:13	14/10/2016 - 12:19:27	
E		Disconnected	00:00:00		

A. SP LINK is connected to the phase 1 (L1) SP PRO of a Powerchain system. The AC Source is in tolerance and the SP PRO is synchronised to the AC Source input.

B. SP LINK is connected to the phase 2 (L2) SP PRO of a Powerchain three phase system. The AC Source is in tolerance but the SP PRO is not synchronised to the AC Source input and is running stand alone.

C. SP LINK is connected to the SP PRO in a single phase system. The AC Source is out of tolerance and therefore the SP PRO is not synchronised to the AC Source input and is running stand alone.

D. SP LINK is connected to the SP PRO in a single phase system. The AC Source is in tolerance but the SP PRO is in Idle (inverter section is off). The SP PRO is in bypass and the AC Source input is running the loads

E. SP LINK is not connected to the SP PRO.

Configuring the SP PRO



To avoid unexpected operation, the SP PRO is prevented from turning on until a configuration setting has been saved by clicking “Configure SP PRO”. The ON LED on the front panel will flash red until the SP PRO has been configured for the first time or after a reset to factory defaults.

With SP LINK connected to the SP PRO, Click “Configure SP PRO” from the File - Configuration Settings menu or the button on the Configuration Setting page.



SP LINK will - unless “Configure SP PRO” has just been performed - warn that all settings will be overwritten.

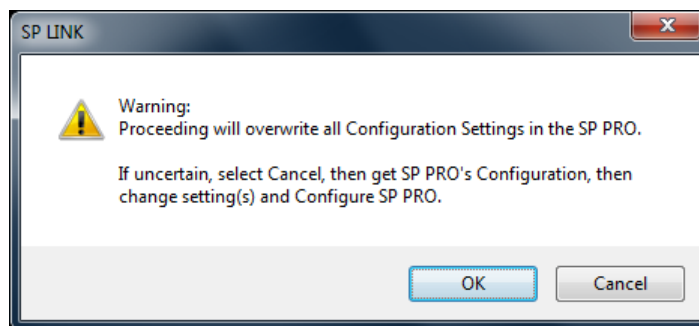

For security purposes, to ensure no-one can tamper with the SP PRO configuration settings, you will now be asked to enter the passcode. This passcode will remain active for five minutes or until the SP PRO is disconnected and will not need to be re-entered until then.

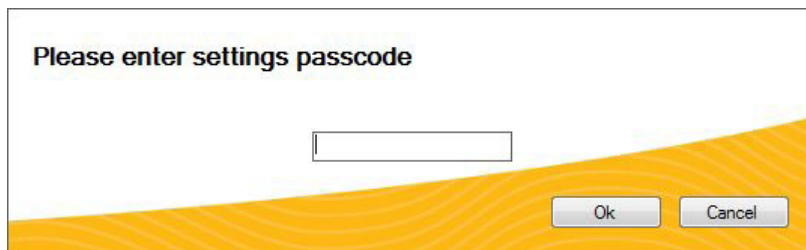

The default passcode is 74, however you can alter this if you wish. We will cover altering the passcode when we get to “Service Settings”.

Once you have entered the passcode click “OK”

SP LINK will verify passcode and configure the SP PRO with these changes.

SP LINK will indicate if for any reason the Configuration was unsuccessful.

You have now transferred all the Configuration Settings shown in SP LINK into the SP PRO. The settings take immediate effect and can be performed with the SP PRO fully operational.

Connection Settings

The connection settings (shown on the next page) show all the connection methods available between SP LINK and the SP PRO. The connection settings need to be set depending on which other communication method is being used. Details of the chosen connection type are stored with the site file.



LOGIN PASSWORD

A LOGIN PASSWORD is required for connecting to the SP PRO. SP LINK can only connect through to the SP PRO with the correct password. The default password is “Selectronic SP PRO”. This is different to the setting passcode.

Powerchain Inverter Assignments tab

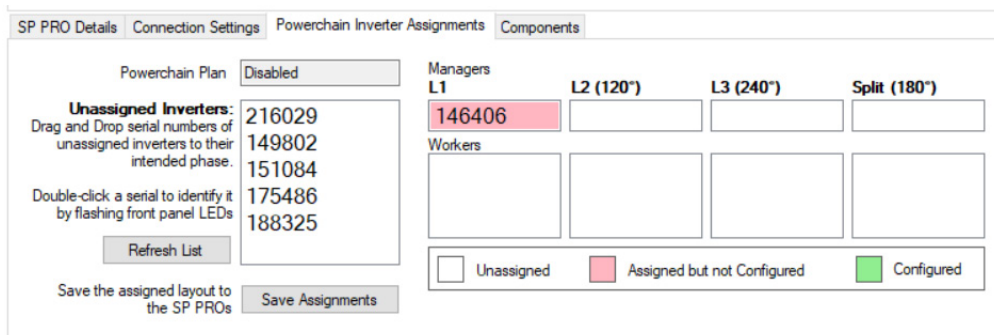

The screenshot shows the 'Powerchain Inverter Assignments' tab. On the left, there is a 'Powerchain Plan' set to 'Disabled'. Below it, a list of 'Unassigned Inverters' includes serial numbers 216029, 149802, 151084, 175486, and 188325. A 'Refresh List' button is present. On the right, there are columns for 'Managers' (L1, L2 (120°), L3 (240°), Split (180°)) and 'Workers'. The L1 manager column contains the serial number 146406, which is highlighted in red. A legend at the bottom indicates: Unassigned (white), Assigned but not Configured (red), and Configured (green). A 'Save Assignments' button is at the bottom right.

This tab is used to set up an SP PRO Powerchain system. Once the SP PRO inverters have been installed in a Powerchain configuration and before they have been configured, SP LINK is connected to the L1 SP PRO. SP LINK will find all the SP PRO inverters in the system and list their serial numbers in this tab. The serial numbers can then be dragged and dropped into their phase and “Save Assignments”.



Double clicking a serial number in this tab will cause the RED battery LEDs to flash on that SP PRO.

For full details on installing a Powerchain system please refer to installation note: IN0057_xx Installation of SP PRO Powerchain system.

When the SP PRO inverters are configured as a Powerchain system then all the inverters in the system can be accessed via the System Manager (the SP PRO that is configured as L1 manager). Only one session of SP LINK, connected to System Manager, is required to access all the SP PROs in the Powerchain.

Once connection is made via SP LINK, the Data View screens and the Service Settings for each inverter in the Powerchain can be accessed by selecting the L1, L2, L3 or Split and manager/worker buttons (as applicable).

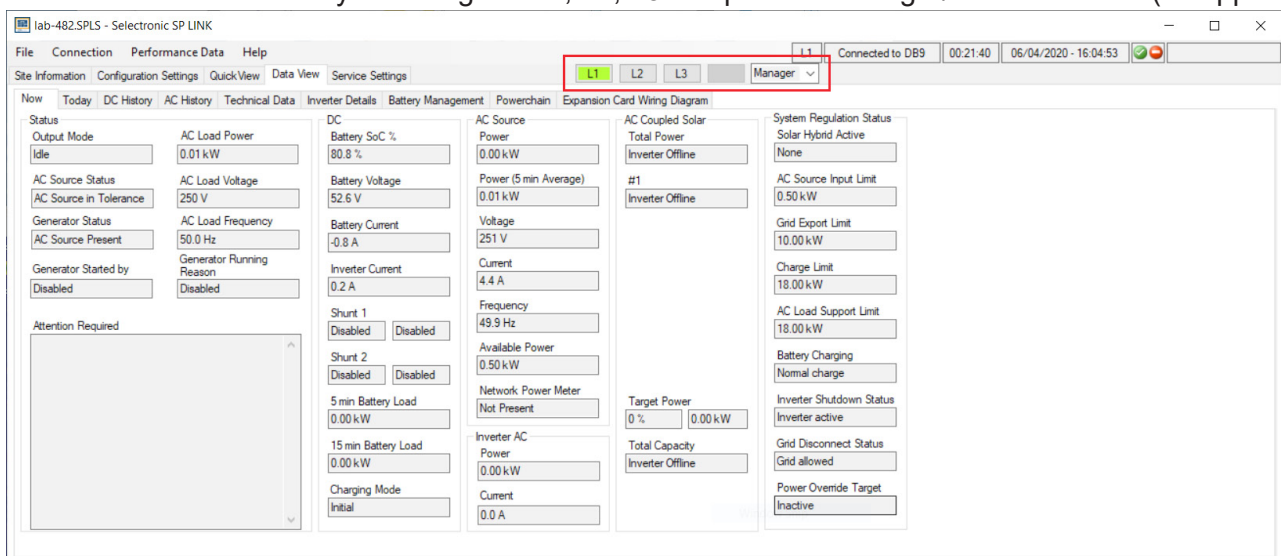

The screenshot shows the 'Data View' screen for an inverter. At the top, there are tabs for 'File', 'Connection', 'Performance Data', and 'Help'. Below that, there are tabs for 'Site Information', 'Configuration Settings', 'QuickView', 'Data View', and 'Service Settings'. The 'Data View' tab is active. The screen is divided into several sections: 'Status' (Output Mode: Idle, AC Source Status, Generator Status), 'DC' (Battery SoC %, Battery Voltage, Battery Current, Inverter Current), 'AC Source' (Power, Power (5 min Average), Voltage, Current, Frequency, Available Power, Network Power Meter), 'AC Coupled Solar' (Total Power, Inverter Offline), 'System Regulation Status' (Solar Hybrid Active, AC Source Input Limit, Gnd Export Limit, Charge Limit, AC Load Support Limit, Battery Charging, Inverter Shutdown Status, Grid Disconnect Status, Power Override Target), and 'Attention Required' (a large empty box). A red box highlights the 'L1' tab and the 'Manager' dropdown menu.

USB - Local connection.

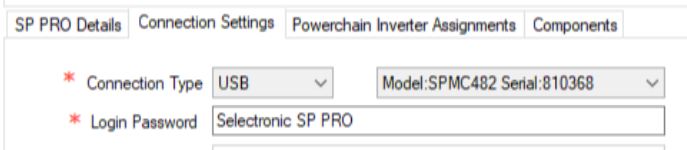

SP LINK will automatically detect and list all SP PRO inverters plugged into the PC via their USB ports. Select the appropriate SP PRO and click the CONNECT button.

Select USB when connecting via a Wireless Zigbee device.

The ATEN or Belkin USB to serial adaptors may also be connected using the USB option. In this case SP LINK will Automatically switch to SERIAL on connection to the SP PRO and save to the Site File.

NOTE - An alternative method for connecting to USB devices is selecting the SERIAL **Connection Type** then:

- Unplug the USB lead from the computer running SP LINK. Leave it plugged into the SP PRO.
- Select Serial **Connection Type** and note the available COM ports.
- Plug the USB lead back into the computer and wait until a new COM port appears in the list.
- Select the new COM port and click the CONNECT button.

SERIAL - Local connection.

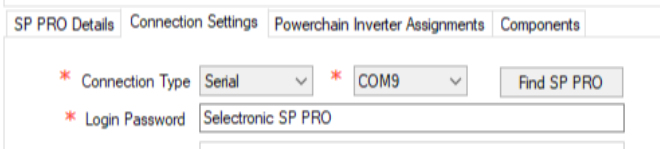

Use SERIAL connection Type when using a RS232 serial connection or as an alternative to a USB connection.

Once all cables are connected and in place, press FIND SP PRO - this will search through all PC ports and find the connected SP PRO and set connection parameters. This Option was previously called Direct.

WIRELESS - Local connection.

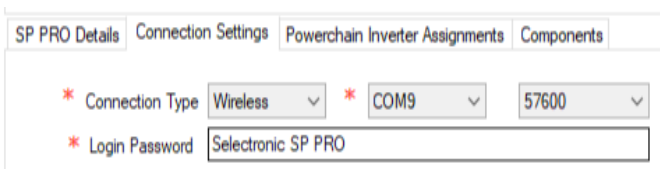

Use Wireless when connecting via a RS232 wireless device. This setting operates similar to SERIAL but allows for the extra delays normally present in a wireless link

MODEM - Remote dial-up connection.

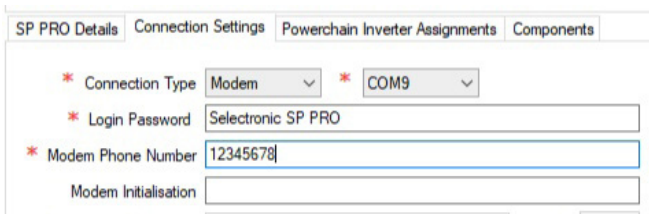

For MODEM connections, select the PC COM port that the modem is connected to. Enter the MODEM PHONE NUMBER. This is the number that SP LINK will dial when you select CONNECT. MODEM INITIALISATION can be left blank when using Selectronic supplied modems but may be required for other modem types. Consult the modem supplier if unsure.

NETWORK - IP connection.

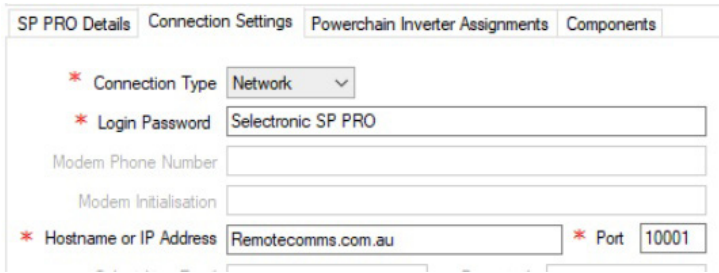

Connection to the SP LINK via a local NETWORK is made using the optional SP PRO Ethernet Adaptor Lead, stock code 005081. enter the HOSTNAME or IP ADDRESS of the serial/Ethernet adaptor and the IP PORT number of the serial connection to the SP PRO.

LOCAL PORT SCANNER.



Use this function to find the IP address of the SP PRO that is connected to the local network via the optional Ethernet adaptor, stock code 005081. First enter the port number of the adaptor then click “Scan Local Network”.

Consult the installation guide supplied with the Ethernet adaptor or an IT specialist for further information.

SELECT.LIVE - REMOTE CONNECTION.

When a select.live unit connected to the SP PRO, SP LINK can connect remotely by using the select.live as a gateway.

Just enter your select, live credentials and click the Connect button. If you have more than one SP PRO associated with your selcet.live account, a list of serial numbers will be displayed. Select the serial number of the SP PRO that you wish to connect to.

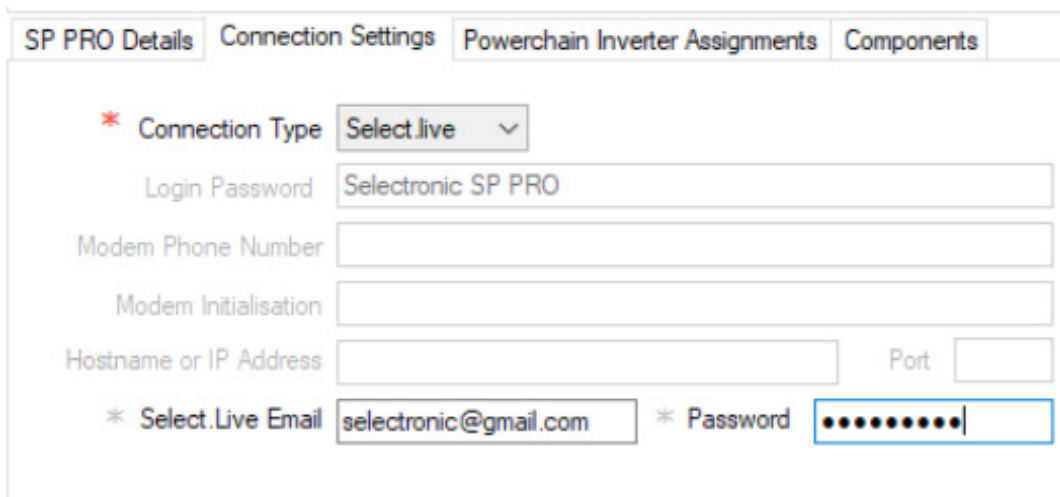

Customising SP LINK to suit the site

The SITE INFORMATION screen on SP LINK allows you to record specific site details that are individual to the installation, such as the SITE NAME, the SYSTEM INTEGRATOR, the inverter SERIAL NUMBER as well as including a photo of the site.

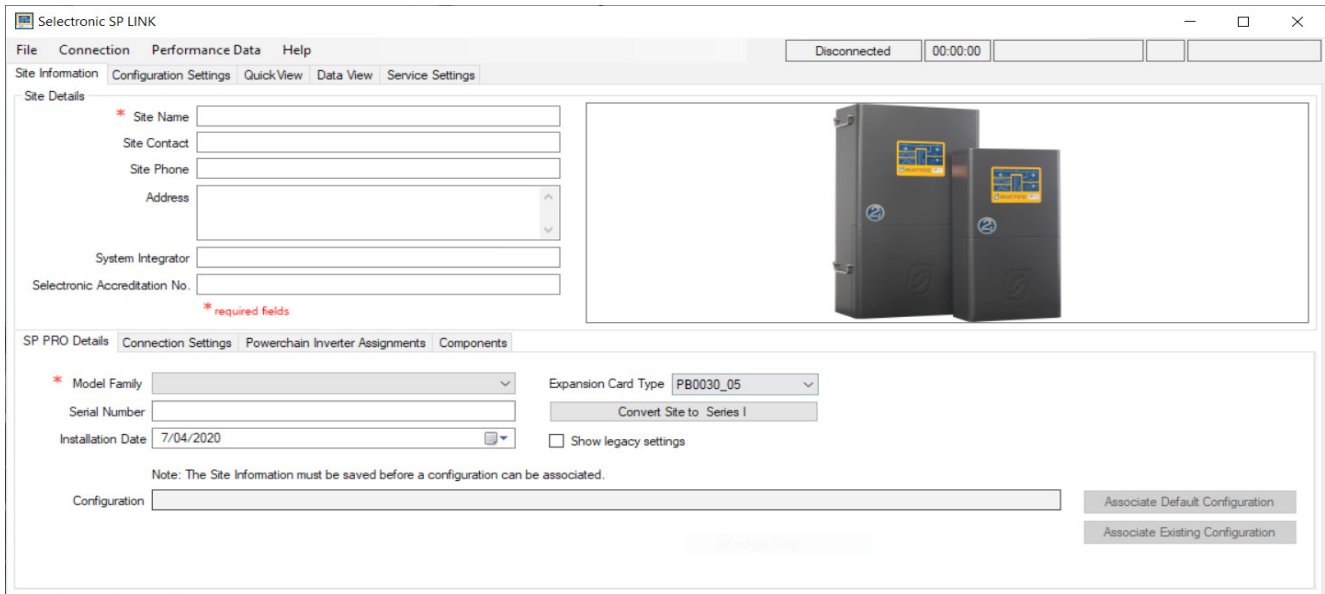

The screenshot shows the 'Selectronic SP LINK' application window. At the top, there are menu options: File, Connection, Performance Data, and Help. Below the menu is a status bar showing 'Disconnected' and '00:00:00'. The main interface has several tabs: Site Information, Configuration Settings, Quick View, Data View, and Service Settings. The 'Site Information' tab is active, showing two sub-sections: 'Site Details' and 'SP PRO Details'.
 In the 'Site Details' section, there are input fields for: Site Name (marked with a red asterisk), Site Contact, Site Phone, Address, System Integrator, and Selectronic Accreditation No. A red asterisk and the text '* required fields' are visible below the accreditation number field. To the right of these fields is a large image placeholder containing a photograph of two black inverter units.
 The 'SP PRO Details' section has tabs for: Connection Settings, Powerchain Inverter Assignments, and Components. It contains:
 - A dropdown menu for 'Model Family' (marked with a red asterisk).
 - An input field for 'Serial Number'.
 - A date picker for 'Installation Date' showing '7/04/2020'.
 - A dropdown menu for 'Expansion Card Type' showing 'PB0030_05'.
 - A button labeled 'Convert Site to Series I'.
 - A checkbox for 'Show legacy settings'.
 - A note: 'Note: The Site Information must be saved before a configuration can be associated.'
 - An input field for 'Configuration'.
 - Two buttons: 'Associate Default Configuration' and 'Associate Existing Configuration'.

In the SP PRO DETAILS screen you can choose from earlier saved configuration files. As an example, you may have two sets of settings for the inverter saved within SP LINK; one for NORMAL everyday use, and one for HOLIDAY use. In the holiday file you may have included automatic garden watering, switching security lights on and off or even switching off the inverter for periods of time.

Changing these settings is as easy as browsing the saved files through the FILE - SITE INFORMATION - ASSOCIATE EXISTING CONFIGURATION menu option or clicking Associate Existing Configuration and selecting the appropriate configuration then clicking on OPEN. This will now load in those settings ready to be configured into the SP PRO.

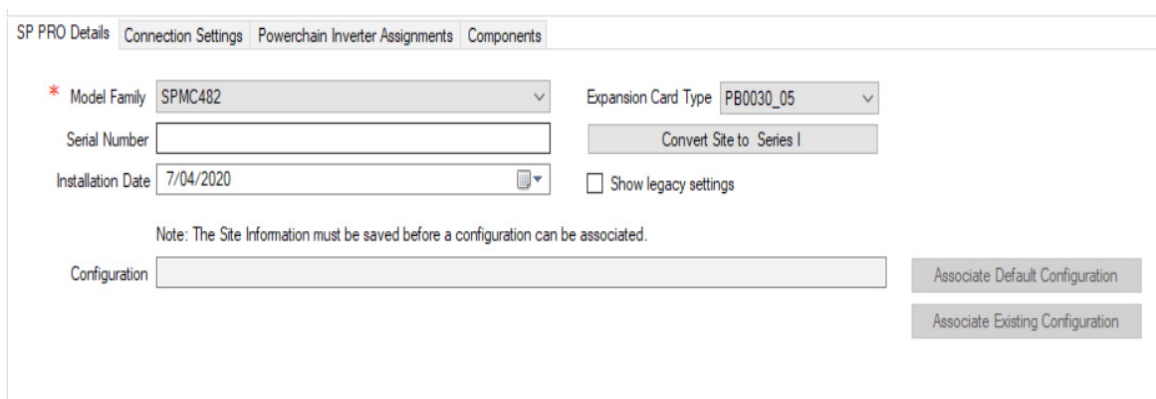

This screenshot is a zoomed-in view of the 'SP PRO Details' section from the previous image. It shows the 'Components' sub-tab selected. The 'Model Family' dropdown is set to 'SPMC482'. The 'Expansion Card Type' dropdown is set to 'PB0030_05'. The 'Installation Date' is '7/04/2020'. The 'Show legacy settings' checkbox is unchecked. The 'Configuration' input field is empty. The 'Associate Existing Configuration' button is highlighted.

Performance Data Retrieval

The SP PRO collects and stores information regarding the complete power system and the operation of the SP PRO. This information can be downloaded to review the system performance or in assisting to identify any potential areas of concern.

From the drop down menu in “Performance Data” you can choose the type of data and how much of it to download from the SP PRO to the computer.

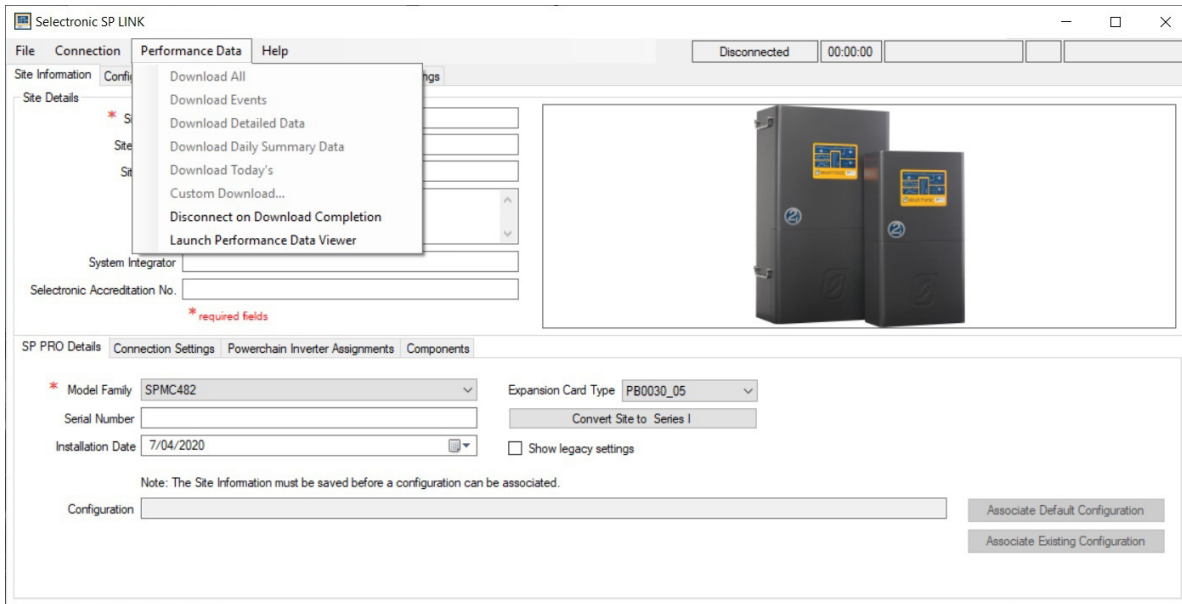

The Performance Data menu gives you the following options but choosing **Download All** will ensure all the data is captured:

Download All

This is the preferred download to use as it contains Events, Detailed, Daily Summary, Configuration and Unit Information. When Seeking support assistance from your Selectronic Accredited Integrator or from Selectronic Support, please perform a Download All and email The .zip file contained in the download directory.

Download Events

Download just Event records - what happened and when

Download Detailed Data

Download just the Detailed data - averages of all parameters like AC Load and Battery Voltage

Download Daily Summary Data

Download just the Daily Summary data - total energy usages on a daily basis

Download Today's

Download all records for Today

Custom Download

Choose the date range and what types of data to download.

You may also wish to select Disconnect on Download Completion from the menu to avoid high data costs on Network or Modem connections.

You can also select Launch Performance Data Viewer directly without having to download any data. This will then allow you to choose previously downloaded data from this or other sites.



Performance Data Viewer

Once the Performance Data Download is complete, you can either

Click OK to continue using SP LINK,

Click Open Download Folder to see the Performance Data files just downloaded,

Click Launch Performance Viewer* to view graphically the Performance Data.

* - Requires Microsoft Excel 2003 or later

The Performance Data Viewer automatically loads and presents the Performance Data graphically and in predefined graphs or a customised graph with any choice of Performance Data plus displays all the Event logging and Daily Performance Data.

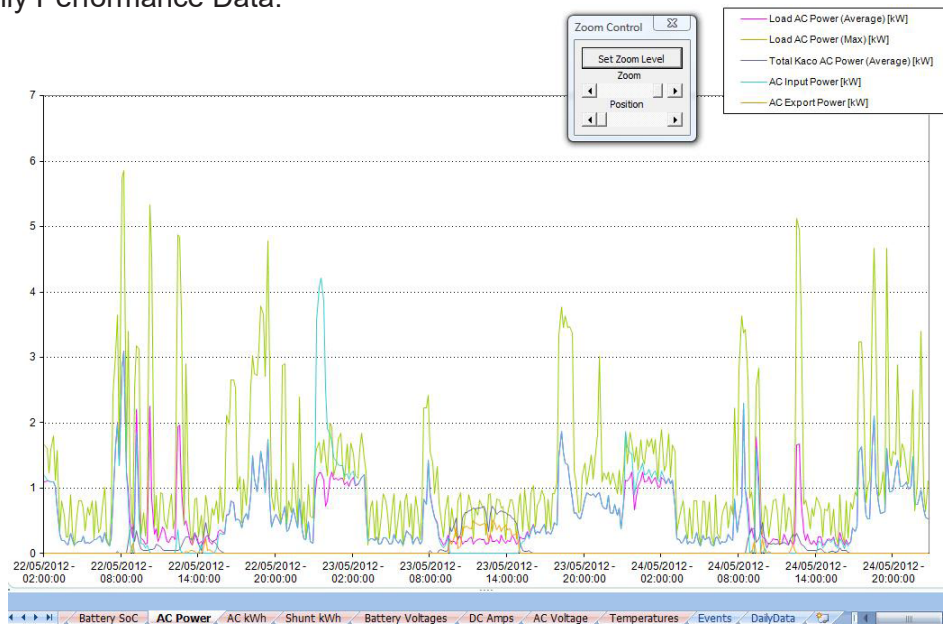

The “Events” tab lists all the Operational and Alert events along with their time stamp and a snap shot of the readings at the time. The Operational events occur during normal operation of the system.

An Alert event normally indicates that there is an issue with the system. For further information on Alert events, see “Appendix One Alert Messages” on page 98 .The table in this section outlines all the SP PRO ALERT type event messages, the most likely cause and possible remedies.

[Click here for Appendix One Alert Messages on page 98](#)

Date/Time Stamp [dd/MM/yyyy - HH:mm:ss]	Event Type	Event Description	Voltage (Instantaneous) [V DC]	Voltage (Instantaneous) [V DC]	DC Current (Instantaneous) [A]	Shunt1 Current (Instantaneous) [A]	Shunt 2 Current (Instantaneous) [A]	Power (Instantaneous) [kW]	AC Power (Instantaneous) [kW]	Power (Instantaneous) [kW]	Voltage (Instantaneous) [V AC]	State of Charge (Instantaneous) [eous %]
23/11/2012 - 13:40:16	Operations	Digital Control Out 3 - On	26.7	13.3	138.8	0	0	0	4.09	0	240.7	89.5
23/11/2012 - 13:25:58	Alert	Inverter - AC Source out of tolerance Beeper Off	26.4	13.2	135.6	0	0	0	3.94	0	240.6	99.5
23/11/2012 - 13:25:58	Alert	Inverter - AC Source out of tolerance Beeper On	26.4	13.2	136	0	0	0	3.96	0	240.3	99.5
23/11/2012 - 13:25:58	Alert	Inverter - AC Source out of tolerance Beeper Off	26.4	13.2	135.4	0	0	0	3.95	0	240.5	99.5
23/11/2012 - 13:25:58	Operations	AC Source - Minimum Sync Frequency detected	26.4	13.2	136	0	0	0	3.96	0	240.3	99.5
23/11/2012 - 13:25:56	Alert	Inverter - AC Source out of tolerance Beeper On	26.4	13.2	135	0	0	0	3.94	0	240.5	99.5
23/11/2012 - 13:25:56	Operations	AC Mode - Standalone begin	26.4	13.2	135	0	0	0	3.94	0	240.5	99.5
23/11/2012 - 13:25:56	Operations	AC Source - Minimum Sync Voltage detected (S)	26.4	13.2	135	0	0	0	3.94	0	240.5	99.5
23/11/2012 - 13:25:48	Alert	Inverter - AC Source out of tolerance Beeper Off	26.4	13.2	135.9	0	0	0	3.96	0	240.4	99.5
23/11/2012 - 13:25:48	Alert	Inverter - AC Source out of tolerance Beeper On	26.4	13.2	136.1	0	0	0	3.97	0	240.6	99.5
23/11/2012 - 13:25:48	Alert	Inverter - AC Source out of tolerance Beeper Off	26.4	13.1	135.5	0	0	0	3.95	0	240.8	99.5
23/11/2012 - 13:25:48	Operations	AC Source - Minimum Sync Frequency detected	26.4	13.2	136.1	0	0	0	3.97	0	240.6	99.5
23/11/2012 - 13:25:41	Alert	Inverter - AC Source out of tolerance Beeper On	26.3	13.1	135.6	0	0	0	3.95	0	240.2	99.5
23/11/2012 - 13:25:41	Operations	AC Mode - Standalone begin	26.3	13.1	135.6	0	0	0	3.95	0	240.2	99.5
23/11/2012 - 13:25:41	Operations	AC Source - Minimum Sync Voltage detected (S)	26.3	13.1	135.6	0	0	0	3.95	0	240.2	99.5
23/11/2012 - 13:25:31	Operations	Digital Control Out 3 - Off	26.3	13.1	136.2	0	0	0	3.95	0	240.5	99.5
23/11/2012 - 13:24:53	Operations	Charger - Initial Stage Start	24.3	12.1	-22.5	0	0	0.55	-0.56	0	239.7	99.5
23/11/2012 - 13:23:52	Operations	Digital Control Input 3 - On	24.4	12.2	-22.5	0	0	0.55	-0.55	0	239.7	99.5
23/11/2012 - 13:23:52	Operations	Generator Controller - Auto Start Available	24.4	12.2	-22.5	0	0	0.56	-0.56	0	239.7	99.5
23/11/2012 - 13:23:49	Operations	Digital Control Input 3 - Off	24.4	12.2	-22.8	0	0	0.56	-0.56	0	239.8	99.5
23/11/2012 - 13:23:49	Operations	Generator Controller - Auto Start NOT Available	24.4	12.2	-22.8	0	0	0.56	-0.56	0	239.8	99.5
23/11/2012 - 13:23:49	Operations	Digital Control Input 3 - On	24.4	12.2	-22.8	0	0	0.56	-0.56	0	239.7	99.5
23/11/2012 - 13:23:49	Operations	Generator Controller - Auto Start Available	24.4	12.2	-22.8	0	0	0.56	-0.56	0	239.7	99.5
23/11/2012 - 13:23:47	Operations	Digital Control Input 3 - Off	24.4	12.2	-22.6	0	0	0.56	-0.56	0	239.8	99.5
23/11/2012 - 13:23:47	Operations	Generator Controller - Auto Start NOT Available	24.4	12.2	-22.6	0	0	0.56	-0.56	0	239.8	99.5
23/11/2012 - 13:23:47	Operations	Digital Control Input 3 - On	24.4	12.2	-22.8	0	0	0.56	-0.56	0	239.6	99.5
23/11/2012 - 13:23:47	Operations	Generator Controller - Auto Start Available	24.4	12.2	-22.8	0	0	0.56	-0.56	0	239.6	99.5
23/11/2012 - 13:22:40	Operations	Digital Control Input 1 - Off	25.1	12.5	-21.8	0	0	0.55	-0.55	0	239.5	100
23/11/2012 - 13:22:40	Operations	Charger - Return to Float Stage	25.1	12.5	-22.4	0	0	0.57	-0.57	0	239.5	100
23/11/2012 - 13:22:40	Operations	Digital Control Input 1 - On	25.1	12.5	-22.3	0	0	0.56	-0.56	0	239.8	100
23/11/2012 - 13:22:40	Operations	Charger - Float Stage Start from digital input	25.1	12.5	-22.3	0	0	0.56	-0.56	0	239.8	100
23/11/2012 - 13:22:40	Operations	Digital Input - Charger to Float Stage	25.1	12.5	-22.3	0	0	0.56	-0.56	0	239.8	100
23/11/2012 - 13:22:40	Operations	Digital Control Input 1 - Off	25.1	12.5	-22.1	0	0	0.56	-0.56	0	239.7	100
23/11/2012 - 13:22:39	Operations	Charger - Return to Float Stage	25.1	12.5	-22	0	0	0.57	-0.57	0	239.7	62
23/11/2012 - 13:22:39	Operations	Digital Control Input 1 - On	25.1	12.5	-22.2	0	0	0.57	-0.57	0	239.8	62
23/11/2012 - 13:22:39	Operations	Charger - Float Stage Start from digital input	25.1	12.5	-22.2	0	0	0.57	-0.57	0	239.8	62
23/11/2012 - 13:22:39	Operations	Digital Control Input 1 - On	25.1	12.5	-22.2	0	0	0.57	-0.57	0	239.8	62

Firmware Update

SP LINK provides a convenient and simple way to update the firmware in the SP PRO inverter. This only needs to be performed if you have been specifically requested to update the firmware which can be done either on-site or remotely.

Before updating firmware make sure you have the latest version of SP LINK, available at www.selectronic.com.au which contains the most recently released firmware.

SAVE CURRENT CONFIGURATION

If you are updating an existing system then it is recommended that the configuration settings within the SP PRO be saved to file before updating firmware:

1. Connect to the SP PRO.
2. Select the Configuration Settings tab.
3. Click the Get SP PRO's Configuration button.
4. Save Configuration settings. (File > Configuration Settings > Save)

SET STRING INVERTER

If the system is using or will use Managed AC Coupling with a Selectronic Certified grid inverter then it is important to set the **String Inverter** setting and configure the SP PRO before Firmware Update. Once this is done the Firmware update process will automatically selected the compatible firmware
See String Inverter on page 59.

FIRMWARE UPDATE PROCESS

Select File > Firmware Update and the SP PRO Basic Firmware Update window will appear and show the Current and the New SP PRO Firmware Information.

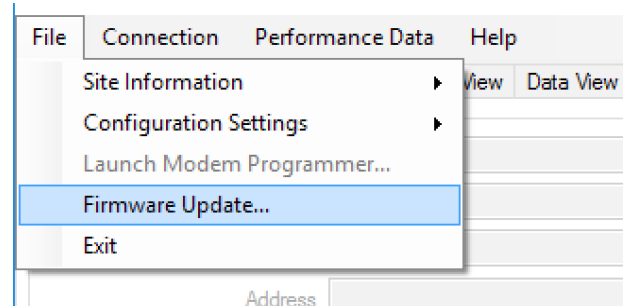

Update Firmware and restart SP PRO on Conclusion:

Use this option to update the firmware in the SP PRO to the firmware version that is included in SP LINK. If you are using the latest SP LINK then this will be the latest firmware.

Once the update is completed and the SP PRO has restarted, this window will close. You are now able to connect to the SP PRO.

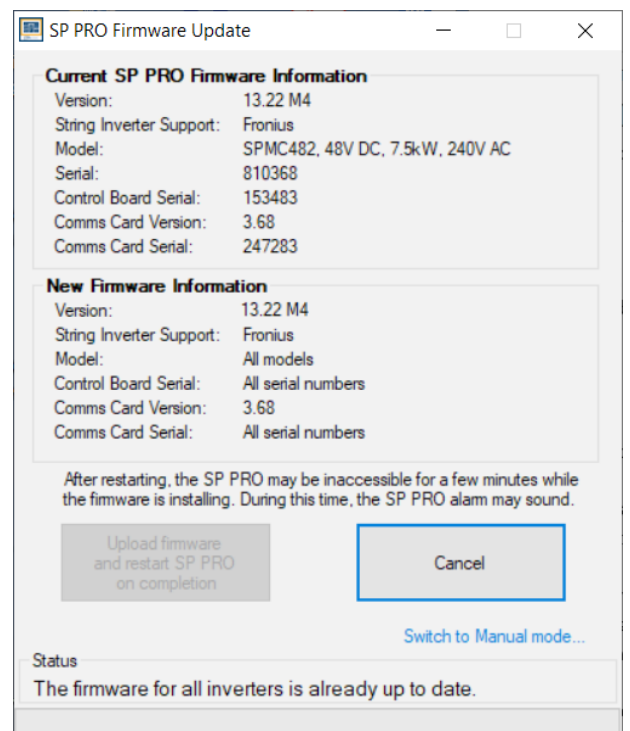

FIRMWARE UPDATE PROCESS - Manual Mode

If you wish to load firmware from file or set up a scheduled restart after the firmware has been sent, then select Advanced Options.... This will take you to a new screen.

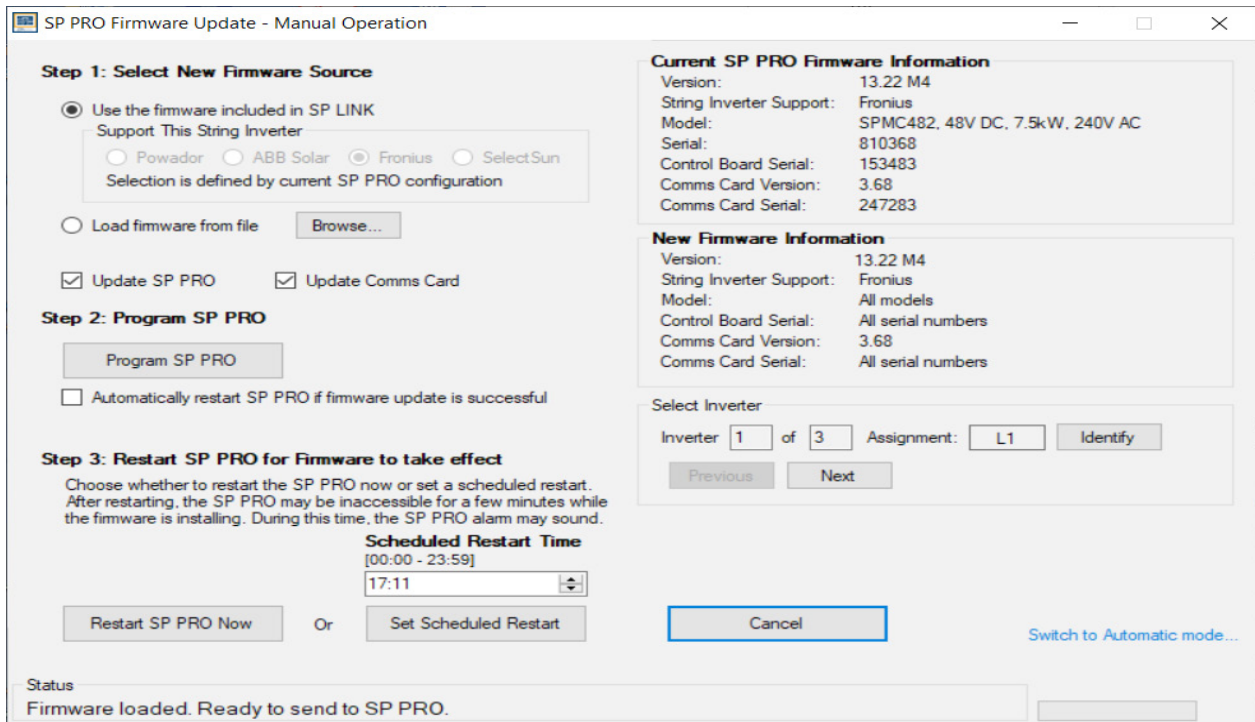

Step 1 You can load the latest firmware (Use the firmware included in SP LINK). If you choose this option then the firmware that is compatible with the string inverter that is set in Configuration Settings > System > String Inverter (see page 59.) will be selected. If no string inverter is configured then you are able to select the compatible string inverter.

This option will perform a firmware update for both the inverter and the Comms Card.

OR

Select firmware from file (Load Firmware from File). If you choose this option you can either select the firmware file for the inverter or for the Comms Card. If you wish to update both the inverter and Comms Card firmware from file then they need to be done one at a time.

Step 2 Check that the **Current SP PRO firmware Information** and the **New firmware Information** are correct before proceeding.

If you wish to **Automatically restart SP PRO if firmware update is successful**, then check this box. WARNING: During the restart AC LOAD will be interrupted.

Click **Program SP PRO**.

SP LINK will begin the update process. There are several stages and this can be monitored in the Status area at the bottom of the SP PRO Firmware Update screen.

When complete there will be either a **Automatically restart SP PRO if firmware update is successful** or Status will indicate: "Firmware Transferred to SP PRO. Proceed with Step 3 (see next page)."

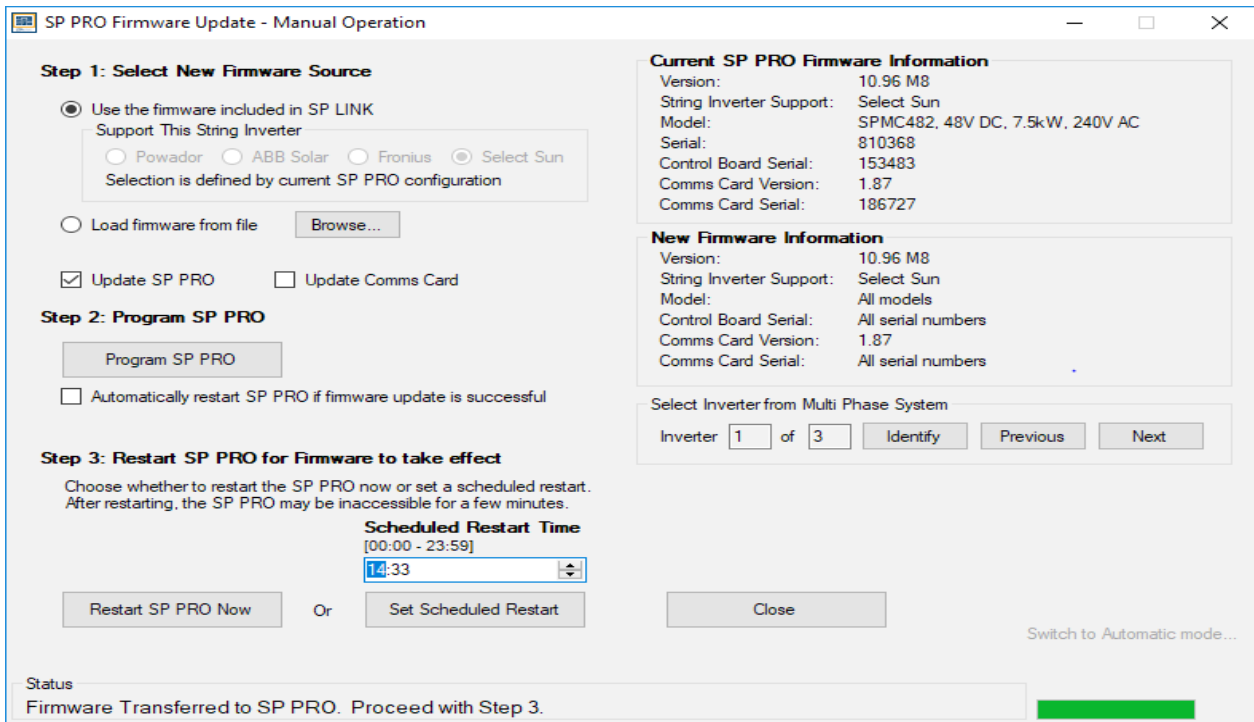

Step 3 If **Automatically restart SP PRO if firmware update is successful** was not checked then the SP PRO must be restarted to complete the firmware update.

WARNING: During the restart AC LOAD will be interrupted.

There are two Restart options:

Click **Restart SP PRO Now**.

The SP PRO will restart and the Firmware Update window will close after the SP PRO has restarted. The SP PRO will revert to Idle mode by default.

OR

Set the **Scheduled Restart Time** (in 24hr format) when a few minutes of interruption in power is least inconvenient.

Click **Set Scheduled Restart**.

The SP PRO is now set to restart at that time and will continue to operate normally.

(If you change your mind about the scheduled restart time, click **Cancel Scheduled Restart**, then set a new value. Or if you click **Restart SP PRO Now**, the inverter will restart immediately and any scheduled restart will be disabled.)

Click **Close**.

At the scheduled time, the SP PRO will restart, appear to be off for a few minutes, then resume operation as it was prior to being restarted.

Firmware Update is now complete.

AUTOMATIC RESETTING THE STATE OF CHARGE (SoC)

During the firmware update process SP LINK reads the SoC from the SP PRO.

When the SP PRO is restarted as part of the firmware update process, the SoC in the SP PRO is lost.

Reconnecting SP LINK after the firmware update is completed will initiate an automatic updated of the SoC back to the SP PRO.

If the SP PRO is communicating with a Battery Management System (such as LG Chem) then the SoC is automatically set by the BMS and this process does not occur.

AFTER UPDATING FIRMWARE

Connect SP LINK to the SP PRO.

For existing systems, load the saved Configuration file into SP LINK and make any required changes to your configuration settings. Check the **String Inverter** setting as this may have changed during the firmware update process (See String Inverter on page 59.)

For new system it is recommended that the Site Configuration Wizard be used now to configure the SP PRO.



For updates from a firmware version that is less than 7.00 to a version that is 7.00 or greater, some settings will no longer be active and reprogramming Configuration Settings may be required. For full details see the document “Migrating Legacy Settings” in the Help menu within SP LINK.

Program your previously saved configuration settings back into the SP PRO using the Configure SP PRO button.



Blank Page



Configuration Settings



The SP PRO series are very advanced and intelligent products with a large number of configuration settings to suit virtually any application. SP LINK is used to create and send a suitable configuration to the SP PRO to enable the required features to achieve the system objectives.

At this stage you can choose to either start a new configuration using the default settings OR use the Site Configuration Wizard to setup a more advanced starting point.

The Configuration Settings are divided into named sections indicating the types of settings within them. Each tab highlights a different configuration area within the SP PRO. To access these settings, click on the various section tabs.

Settings can be changed by either clicking on the drop down list or directly changing the value. Every time you change a setting the title of that setting becomes highlighted in yellow. This is to remind you that you have changed this setting. This highlight disappears when you either save the configuration to file or the SP PRO. (Click "Configure SP PRO" button).

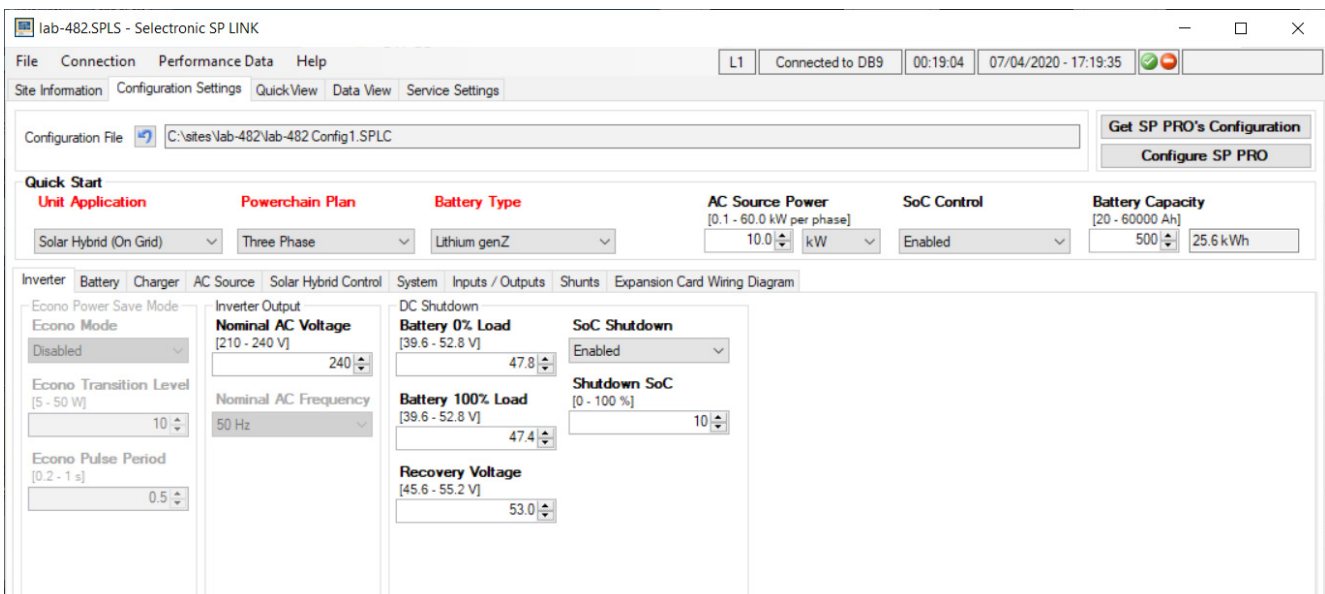

The following pages detail each tab and individual setting contained within.



Quick Start

The Quick Start section provides the settings needed to be considered for all applications.

Unit Application determines how you will use the SP PRO.

- Off Grid for remote area homes with a backup motor generator and no grid.
- Mobile for Motor homes, Caravans & Boats.
- On Grid (Solar Hybrid) for connecting Solar, Wind or Hydro power to the electricity grid. Used for Self Consumption of renewables whilst providing back up power.

Powerchain Plan programs the SP PRO for a Powerchain System. (For more information see IN0057_xx Installation of SP PRO Powerchain System.

Battery Type programs the SP PRO with the appropriate default charging parameters.



The default parameters will be suitable for most battery brands but to ensure maximum battery performance and life, please refer to the battery manufacturers recommendations when programming Battery charging parameters. (Charger tab).



IMPORTANT: When using Lithium Battery or similar technologies, the battery bank **MUST** have a Battery Management System (BMS) that monitors and fully protects the battery bank. The BMS **MUST** have its own independent disconnect that will fully isolate the battery bank from the system in the event of an adverse or alarm condition.

AC Source Power configures the maximum allowable power drawn from the AC supply whether it be from a grid supply or motor generator set. Using the right hand drop down menu choose kW, kVA or Amps. The setting will scale accordingly. The SP PRO will try and keep its power draw below this value and will only exceed it when the load is greater than the inverter capacity plus this value.

State of Charge (SoC) control gives you the option of controlling the system with either battery state of charge or battery voltage.



It is important to note, that for State of Charge control to operate correctly, the SP PRO must be able to read and monitor any charge or discharge of the battery, external to the SP PRO. External current shunts will need to be installed for all DC charging sources or DC loads. Currents shunts are configured under the "Shunts" tab. The SP PRO does NOT need a shunt for it's own battery current or for any installed AC coupled solar.

Enabling State of Charge Control provides greater flexibility in system programming and will allow the battery indicator on the front of the inverter to display usable charge in the battery like the fuel gauge in your car. If State of Charge is disabled the battery indicator will show the battery voltage from the Low DC Shutdown level (no LEDs on) to the Float Charge Voltage level (all LEDs on).

When **Battery Type** setting is a Managed Battery (with BMS communications. e.g. BYD) this control is always enabled and the battery SoC is read from the battery BMS.

Battery capacity is used by the SP PRO to calculate the battery's State of Charge. To determine the Battery Capacity first determine the average discharge C rate over a day. Then use the battery manufacturers specification to determine the battery capacity. For a typical off grid system use the battery capacity at the C50 or C100 rate. A solar hybrid system will normally use the battery capacity at the C10 - C20 rate.



It is safer to use a lower value of battery capacity if unsure

Quick Start

Unit Application

Off Grid

Powerchain Plan

Three Phase

Battery Type

Lithium LiFePO4

AC Source Power

[0.1 - 15.0 kW]

6.0

kW

SoC Control

Enabled

Battery Capacity

[20 - 10000 Ah]

625

30.0 kWh



Inverter Settings

The Inverter tab shows the output settings and minimum battery levels for the inverter to operate within.

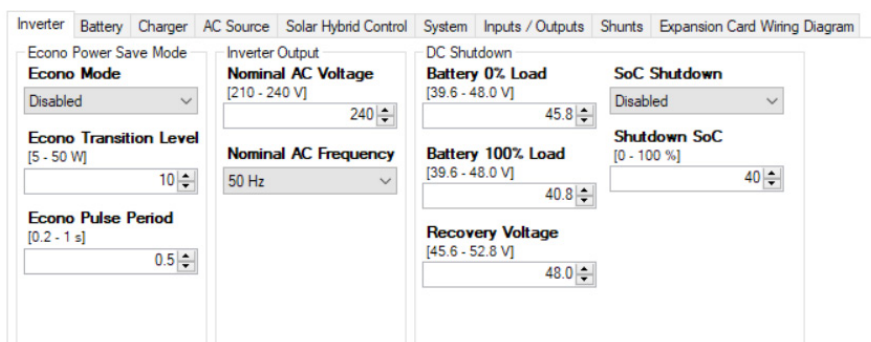

Econo Mode is a legacy setting and is no longer available.

INVERTER OUTPUT sets the **Nominal AC Voltage** and the **Nominal AC Frequency** of the inverter. For example, in Australia this is 240 volts and 50 Hz.

Nominal AC Frequency is set to 50Hz and cannot be changed with firmware versions 14.00 and above. With older versions of firmware 50Hz or 60 Hz may be selected

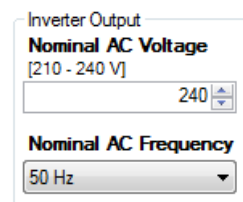

DC SHUTDOWN uses battery voltage to control how far the batteries will discharge before the inverter will switch itself off. These settings are important as discharging batteries too far can make them hard to recharge or even damage the batteries.

Battery 0% Load is the voltage at which the inverter will shutdown with no load applied to the battery including any DC loads. **Battery 100% Load** is the shutdown voltage when 100% battery load is applied. 100% battery load is when the battery current is equal to 20% of the battery capacity (C/5). When the battery load is between these two levels the SP PRO will calculate a shutdown voltage based on these two voltages.

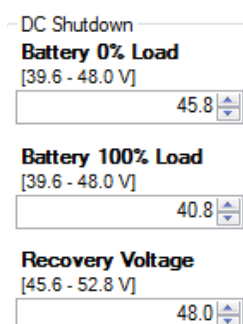

Battery load is only the energy coming from the battery. As an example, in an AC Coupled system with no AC Source, 2 kW of AC Load and 2 kW of solar there will be NO load on the battery so the DC shutdown will be at the **Battery 0% Load** voltage .

Recovery Voltage When the inverter shuts down due to low voltage this setting is the voltage at which the inverter will start up again. It is wise to make this voltage high enough to ensure that sufficient recharging has occurred before the inverter turns on again.

SoC Shutdown.(Only available when SoC Control is Enabled) Programs the inverter to shutdown in response to the state of charge of the battery. When enabled the **Shutdown SoC** can be set anywhere between 0 and 100%. For a lead acid battery this will generally be 40-60% but confirm this with the battery supplier.

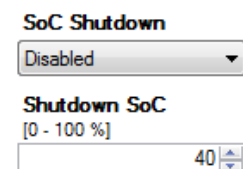

To Recover from either a Low battery voltage or Low SoC shutdown in a system with AC coupled solar, connect an AC Source (either grid or generator) to the SP PRO. The SP PRO will synchronise to the AC Source and start charging the battery bank.

In a well designed Off Grid system the batteries should only get to the Shutdown SoC during a fault condition (e.g. Generator failed to start).

For a well designed Solar Hybrid (On Grid) system the Shutdown SoC would only be reached during a grid outage.

The **Shutdown SoC** setting also determines the lowest reading (one LED on) of battery indicator display on the front panel of the SP PRO.



Battery Settings

The Battery Tab contains settings intended to protect and maintain the batteries.



Please note that you must comply with the requirements of the batteries specifications, failure to do so may void the battery warranty. When in doubt, consult the battery supplier.

Inverter	Battery	Charger	AC Source	Solar Hybrid Control	System	Inputs / Outputs	Shunts	Expansion Card	Wiring Diagram
Limits									
Max Charge Voltage [48.0 - 68.4 V]									
61.0									
Hi Battery Alert [54.0 - 68.4 V]									
68.0									
Hi Battery Alert Clear [54.0 - 68.4 V]									
67.0									
AC Coupled Trip [48.0 - 72.0 V]			BMS Charger Adjustment Float Voltage Adjust [-20.0 - 0.0 %]			Battery Periodic Equalise [2 - 100 d]		Mid Point Monitoring [2 - 10 %]	
61.0			0.0			Disabled		Enabled	
Over Target Charge Voltage Trip [0.0 - 25.0 %]			Current Target Scale [90.0 - 100.0 %]			Equalise Period [2 - 100 d]		Mid Point Range [2 - 10 %]	
5.0			100.0			28		5	
Over Target Charge Current Trip [0.0 - 25.0 %]			Soft Battery			Periodic Recharge [2 - 100 d]		Equalise Request	
10.0			Disabled			28		Enabled	
Trip Delay [0.2 - 20.0 s]									
5.0									
SoC Setting Peukert's Exponent [1.00 - 1.50]					Over Temp. Protection Limit Charge above [35 - 70 °C]				
1.00					45				
					Limit Rate [0 - 20 %]				
					10				

Max Charge Voltage is the absolute maximum voltage produced by the charging section of the inverter in any charge stage.

Hi Battery Alert initiates an alarm when the battery voltage exceeds this level.

When either “Generic AC Coupling” or “String Inverter” has been set (in System tab. See page 24) this setting has an additional protection function. When the Hi Battery Alert voltage has been exceeded for a few seconds indicating a fault in the AC coupled installation, the SP PRO will ramp the frequency of its AC output to 55Hz to disconnect all connected AC coupled grid inverters thereby removing all AC coupled charging sources.

When the battery voltage falls to the value set in **Hi Battery Alert Clear** the alarm stops.

AC Coupled Trip is the battery voltage at which the SP PRO will trip any Managed AC coupled Solar to zero output. This is a legacy setting and is not used in firmware versions greater than 9.09. This is replaced by the **Over Target Charge Voltage Trip** setting.

Over Target Charge Voltage Trip is the percentage over the battery charge target voltage at which the SP PRO will trip any Managed AC coupled Solar to zero output. This setting is used for Lithium battery or similar technologies that have an absolute maximum battery charge voltage.

Over Target Charge Current Trip is the percentage over the battery charge target current at which the SP PRO will trip any Managed AC coupled Solar to zero output. This setting is used for Lithium battery or similar technologies that have an absolute maximum battery charge current.

Trip Delay. When the charge voltage or the charge current exceeds the **Over Target Charge Voltage Trip** or **Over Target Charge Current Trip** respectively for this time, then any Managed AC coupled Solar will trip to zero output. These settings are used for Lithium battery or similar technologies that have an absolute maximum battery charge voltage or current.

Float Voltage Adjust Only functional when a BMS is used. Some lithium batteries need to have the charge target voltage reduce slightly when the battery reaches full charge. This is to prevent over charging the battery bank and tripping the BMS shutdown.

Current Target Scale Only functional when a BMS is used. Scales the BMS target charge current to account for any calibration errors in the battery BMS. Particularly useful when the shutdown function in the BMS does not tolerate even the slightest over target charge current.

Limits
Max Charge Voltage [48.0 - 68.4 V]
66.0
Hi Battery Alert [54.0 - 68.4 V]
68.0
Hi Battery Alert Clear [54.0 - 68.4 V]
67.0

AC Coupled Trip
AC Coupled Trip [48.0 - 72.0 V]
61.0
Over Target Charge Voltage Trip [0.0 - 25.0 %]
5.0
Over Target Charge Current Trip [0.0 - 25.0 %]
10.0
Trip Delay [0.2 - 20.0 s]
5.0

BMS Charger Adjustment
Float Voltage Adjust [-20.0 - 0.0 %]
0.0
Current Target Scale [90.0 - 100.0 %]
100.0



Periodic Equalise. Battery banks used in cyclic applications may, over time develop charge (and voltage) imbalances and may require an “equalise” charge . How often an equalise occurs is set using **Equalise Period**. The equalise charge voltage, current and duration are set in the CHARGER tab. (See “Charger Settings” section)

When an equalise charge is carried out by a charging source that is external to the SP PRO (i.e. DC coupled solar or wind sources) the SP PRO monitors this and reschedules its equalise. For the SP PRO to reschedule, the battery voltage must be taken to or above the EQUALISE STAGE voltage for the EQUALISE TIME settings in the SP PRO therefore it is important to match or slightly exceed these setting in the external renewable controller.

Periodic Recharge is for systems that remain on Float charge for long periods of time such as Solar Hybrid or Boats in Marinas. Battery banks operating in these conditions benefit from periodically being put through a full charge process. When enabled, after remaining in Float for the number of days set by the **Recharge Period**, the SP PRO will return to Initial charge stage.

Soft Battery setting is only available when Custom Battery Type is selected and is for battery banks that are “soft” meaning they have a relatively high internal impedance. Useful with aqueous type battery technologies or battery banks with high internal impedance. Technically this function is achieved within the SP PRO by reducing the gain of the battery charger’s voltage control loop thereby increasing the damping of said loop. Settings are Softness 1 to Softness 6 with Softness 6 being the “softest” setting.



This setting is only effective with battery technologies that have an inherently high internal impedance such as aqueous type technologies. Using this setting with serviceable lead acid or lithium battery technologies may cause unintended charger operation and in some cases over voltage shutdowns.

Mid Point Monitoring is a function designed to highlight any significant voltage variation between one half of the battery bank and the other. If one half of the bank is lower than the other it may suggest that the batteries need an equalisation charge or, perhaps, that there is a cell in one half that is not performing correctly. In **Mid Point Range** you determine how much variation between the two halves you will allow before notification. With this function you can help predict battery problems. To make use of this feature you will need to install an additional wire to the battery, see installation section for details. We recommend the use of this handy feature.

Often these problems can be solved by an equalisation charge so we have included provision for you to request such a charge by enabling the **Equalise Request** setting.

Peukert’s Exponent is a legacy setting and is not required in SP PRO firmware versions 7.06 and greater. The firmware now intelligently learns and compensates for the battery performance resulting in a more accurate SoC calculation.

OVER TEMP. PROTECTION This feature reduces the charge current automatically as the battery temperature rises above the temperature specified in **Limit Charge above**. It reduces the charge current by the **Limit Rate** for every degree Celsius that the temperature is above the temperature specified.

With the default settings the charge rate will drop 10% for every degree over 45°C. e.g. no charging current at 55°C.

Battery

Periodic Equalise
Enabled

Equalise Period
[2 - 100 d]
28

Periodic Recharge
Disabled

Recharge Period
[2 - 100 d]
28

Soft Battery
Disabled

Mid Point Monitoring
Disabled

Mid Point Range
[2 - 10 %]
5

Equalise Request
Enabled

SoC Setting
Peukert's Exponent
[1.00 - 1.50]
1.15

Over Temp. Protection
Limit Charge above
[35 - 70 °C]
45

Limit Rate
[0 - 20 %]
10



Charger Settings

This tab shows all the settings relating to the DC voltages and currents used in the battery recharge stages.

The normal charge cycle involves a four stage charge – Initial, Bulk, Absorption and Float– while periodically it is necessary to go one stage further, for the performance and longevity of the battery bank, to the Equalise stage. We will describe each of these stages as we progress.

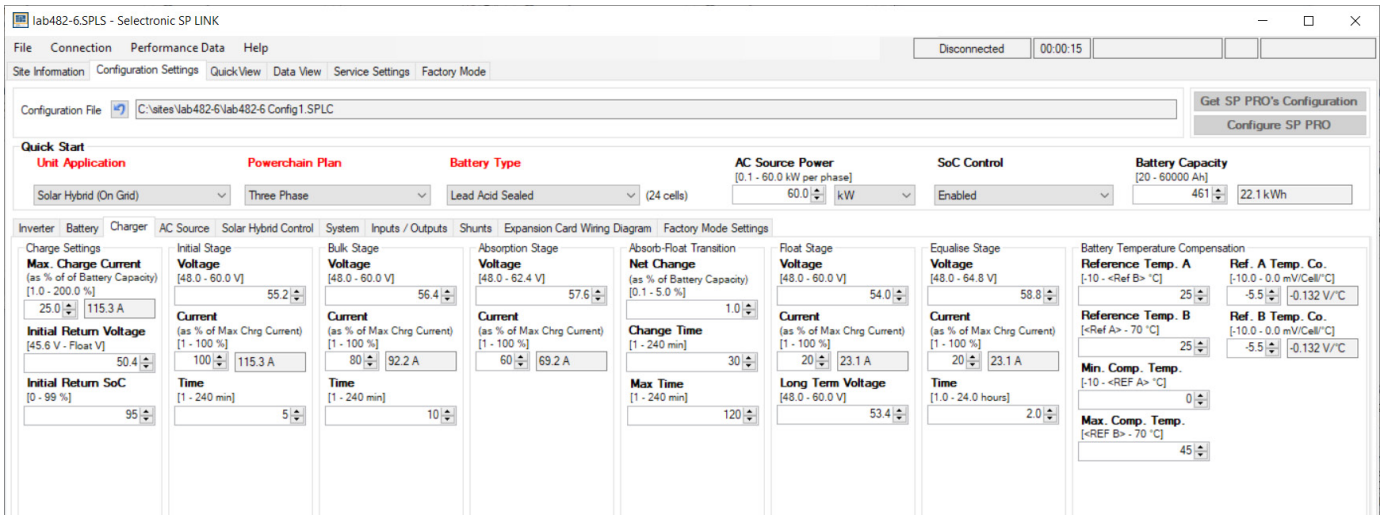

The default charge settings should be considered as safe for most battery types. Exact charging parameters should be confirmed with the battery supplier.

Max. Charge Current is the maximum charge current that the inverter will allow to the batteries under any circumstances (including all external charge currents) at any charge stage. This is expressed as a percentage of the battery capacity. For example if the battery capacity is 900 amp hours and the battery manufacturer suggests a maximum charge current of 10% of capacity then you would set this figure at 10% and the maximum charge current limit would be set at 90 amps. If, in this case there is 40 A of solar charge current, the inverter will add to this a maximum of 50 A of charge into the battery.

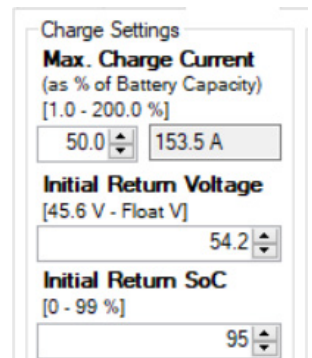

Initial Return Voltage is the voltage level at which the charge cycle will return to the beginning, or Initial, stage of the charge process. The battery voltage must remain at or below this level for 2 minutes to switch to Initial. This ensures that short term loads do not prematurely cause the charger to reset to Initial. The setting will turn RED when it exceeds the lowest float voltage (either Float or Long term Float) minus 5% for Lead Acid or 2% for Lithium or Custom Battery Types. Care should be taken when setting in the RED region to ensure the Float or Long term Float voltages cannot trigger the Initial return under the maximum battery temperature conditions.

Initial Return SoC The Charge cycle will also revert to the INITIAL stage when the battery SoC drops below this setting. This is to ensure the charger will still initialise under light battery loads that do not take the battery voltage below the Initial return voltage.

INITIAL STAGE: The purpose of the INITIAL STAGE of the charging process is to raise the battery voltage quickly with a large charge current. In this section you set the **Voltage** you wish the batteries to reach, the **Current** you wish to charge at and the length of **Time** the batteries will stay at that voltage until the inverter moves to the next stage of the charge cycle.

The current is expressed as a % of the maximum charge current. Using our previous example if the maximum charge current was 90 amps and you wish to charge, in this stage, at ~85 amps you would insert 95 in this area. i.e. 95% of 90 amps = 85.5 amps

Initial Stage

Voltage
[48.0 - 60.0 V]

Current
(as % of Max Chrg Current)
[1 - 100 %]

Time
[1 - 240 min]

BULK STAGE is the part of the charge cycle where the majority of the charging takes place. This is normally set at a higher **Voltage** than the initial stage but at a lower charge **Current**. The **Time** setting determines, once the Bulk **Voltage** is reached, how long the batteries stay at this level until the inverter starts the next stage of the charge process.

Once again using our example if you wanted this stage to charge at ~80 amps you would insert 90 as the setting because 90% of 90 amps is 81 amps. The time that the charge stage would remain at this voltage would normally be set longer than in the initial stage.

Bulk Stage

Voltage
[48.0 - 60.0 V]

Current
(as % of Max Chrg Current)
[1 - 100 %]

Time
[1 - 240 min]

ABSORPTION STAGE is the part of the charge process that allows the batteries to maximise the effect of the previous charge stages. This stage is normally set to a higher **Voltage** than the two previous stages but a lower charge **Current**. The **Max Time** it would remain in this stage is longer again than the previous stages.

This section has a further level of control in that it will also end this stage and transition to Float if the change in current becomes less than the **Net Change** setting for a period equal to the **Change Time** setting.



When "System SoC" shunt is configured (see Shunt Settings) then the current measured by this shunt type is used for the change in **Net Charge**.

For example if you have set the absorption **VOLTAGE** to 57.6 volts, the **CURRENT** to 60% (54 amps) and the **MAX TIME** to 120 minutes, then the battery will be charged at 54 A until the battery voltage reaches 57.6 volts. At this point the battery charging stage will change from Absorption into Float based on which of the following occurs first:

1. The rate of change in charge current is low. For example the battery bank capacity is 900 Ah, **NET CHANGE** is set to 1% and **CHANGE TIME** set to 30 minutes. Transition to Float will occur when net battery charge current has not changed by more than 9 A in 30 minutes.
2. The **MAX TIME** has expired. This is the maximum time the charger will stay in the Absorption stage after the battery voltage has reached the **VOLTAGE** setting..

Absorption Stage

Voltage
[48.0 - 62.4 V]

Current
(as % of Max Chrg Current)
[1 - 100 %]

Absorb-Float Transition

Net Change
(as % of Battery Capacity)
0.1 - 5.0 %]

Change Time
[1 - 240 min]

Max Time
[1 - 240 min]



FLOAT STAGE :After completion of the charge cycle the inverter will enter the FLOAT STAGE. This setting reflects a **Voltage** that the system will maintain, with a good state of charge, for a long period. If the generator continues to run past the absorption or equalise stage for any reason, such as maintaining a high load, the inverter will keep the batteries at the float stage **Voltage** – not exceeding the **Current** set – until the generator is shut off. When the generator or mains voltage is present for longer than 24 hours the charger will drop to the **Long Term Voltage** to maintain a good state of charge for the lowest charge current. This is particularly useful in boating marinas where shore power may be connected for long periods.



SoC will be set to 100% when Float Charging mode is entered.

Float Stage

Voltage
[48.0 - 60.0 V]
54.0

Current
(as % of Max Chrg Current)
[1 - 100 %]
20 31 A

Long Term Voltage
[48.0 - 60.0 V]
53.4

THE EQUALISE STAGE is not employed every time the batteries are charged but is a periodic charge process that raises the battery **Voltage** above the normal voltage settings to a point where the batteries will, essentially be in a state of overcharge.

This is necessary to overcome any variations in voltage between individual cells that occur naturally in a battery bank that is cycled between load and charge cycles. These variations can cause a drop in performance in the battery bank and must be “equalised”.

In flooded cells this process is sometimes called “gassing”, that is when the batteries sound as if they are lightly boiling. In flooded cells this bubbling helps to circulate the electrolyte fluid within the cells.

The Equalise stage will raise battery voltage to the equalise **Voltage** level and maintain this voltage for the equalise **Time**. The equalise **Current** will not be exceeded. If using Sealed batteries, the EQUALISE STAGE may be at the same voltage as Absorption voltage but for a longer period of time. Check with the Battery supplier.

Equalise Stage

Voltage
[48.0 - 64.8 V]
58.8

Current
(as % of Max Chrg Current)
[1 - 100 %]
20 31 A

Time
[1.0 - 10.0 hours]
2.0

TEMPERATURE COMPENSATION: Most lead acid batteries require the charging voltages to change with temperature (Temperature Compensation). The temperature compensation between the **Min. Comp. Temp** and **Reference Temp. A** is set in the **Ref. A Temp. Co.** The temperature compensation between the **Max. Comp. Temp** and **Reference Temp. B** is set in the **Ref. B Temp. Co.**

The temperature compensation between the **Reference Temp A** and **Reference Temp. B** is zero and equals the charge voltage setting.

Ref. A Temp. Co. and **Ref. B Temp. Co** sets the charge voltage change in mV per deg C for each 2V cell .

Battery Temperature Compensation

Reference Temp. A [-10 - <Ref B> °C] 25	Ref. A Temp. Co. [-10.0 - 0.0 mV/Cell/°C] -5.0 -0.12 V/°C
Reference Temp. B [<Ref A> - 70 °C] 30	Ref. B Temp. Co. [-10.0 - 0.0 mV/Cell/°C] -3.0 -0.072 V/°C
Min. Comp. Temp. [-10 - <REF A> °C] 0	
Max. Comp. Temp. [<REF B> - 70 °C] 45	

For example using settings in the diagram to the right and assuming a 48V battery bank (24 cells) and a charging voltage target of 57.6V (absorption stage).

$$\text{Charge voltage at } 10\text{C} = 57.6 + ((10-25) \times -5.0 \times 24 / 1000) = 59.4\text{V}$$

$$\text{Charge voltage at } 40\text{C} = 57.6 + ((40-30) \times -3.0 \times 24 / 1000) = 56.88\text{V}$$

Charge voltage between 25C and 30C is 57.6V

For your reference the total voltage compensation per deg C for the battery pack is displayed.

Temperature compensation is set to zero and is not available when Lithium Batty Type is selected.

AC Source Settings

The next tab in our settings menu is the AC Source tab. In this section we are able to change important settings relating to either the generator or the mains voltage. We use the words AC Source rather than Generator or Grid power as the SP PRO can be used in a variety of applications which include either of those AC supplies.

There are five sub-tabs within this section:

- AC INPUT, relates to general settings that apply if either a generator or the mains grid are used as input power.
- POWER QUALITY / DRM. Grid settings for compliance to AS4777.2-2015. power quality modes.
- GENERATOR AUTO START relates to conditions that will start the generator automatically.
- GENERATOR SCHEDULE START allows programming of scheduled run times for the system.
- GENERATOR CONTROLLER SETTINGS is used to set up parameters that relate to the motor generator.

AC Input

This tab allows you to change the conditions under which the AC Input will be utilised by the SP PRO and transferred through to the AC Load.

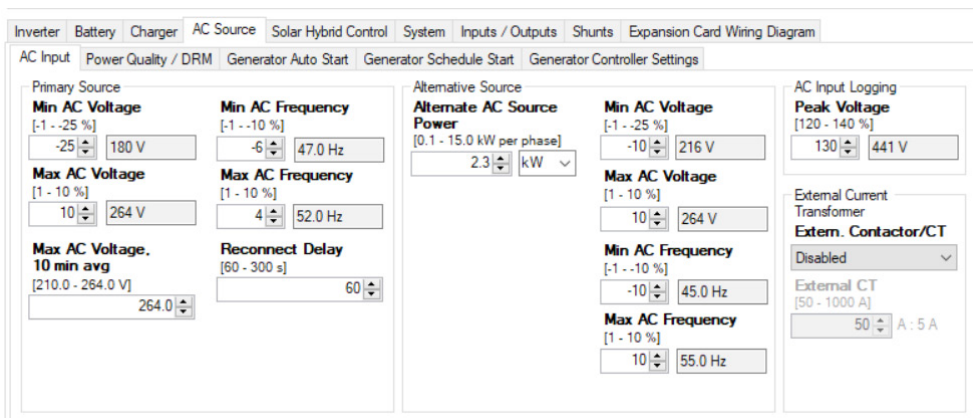

The screenshot shows the 'AC Source' configuration window with several sub-tabs. The 'AC Input' sub-tab is active, showing settings for 'Primary Source' and 'Alternative Source'. The 'Primary Source' settings include: Min AC Voltage [-1 - -25 %] at 180 V, Max AC Voltage [1 - 10 %] at 264 V, Max AC Voltage, 10 min avg [210.0 - 264.0 V] at 264.0 V, Min AC Frequency [-1 - -10 %] at 47.0 Hz, Max AC Frequency [1 - 10 %] at 52.0 Hz, and Reconnect Delay [60 - 300 s] at 60. The 'Alternative Source' settings include: Min AC Voltage [-1 - -25 %] at 216 V, Max AC Voltage [1 - 10 %] at 264 V, Min AC Frequency [-1 - -10 %] at 45.0 Hz, and Max AC Frequency [1 - 10 %] at 55.0 Hz. The 'AC Input Logging' sub-tab shows Peak Voltage [120 - 140 %] at 441 V. The 'External Current Transformer' sub-tab shows Extern. Contactor/CT set to Disabled and External CT [50 - 1000 A] at 50 A: 5 A.

THE PRIMARY SOURCE configurations set the AC voltage and frequency at which the AC Source will disconnect and the reconduction time for the grid.

Min AC Voltage AND Max AC Voltage. These parameters are set as a percentage of the Nominal AC Voltage setting (under the Inverter tab). If the AC Source voltage goes outside these limits the SP PRO will disconnect from the AC Source. The defaults (as shown) are for Australia and NZ.

Min AC Frequency AND Max AC Frequency. The parameters are set as a percentage of the Nominal AC Frequency setting (under the Inverter tab). If the AC Source frequency goes outside these limits the SP PRO will immediately disconnect from the AC Source. The defaults (as shown) are for Australia. For NZ. set the Min AC Frequency to -10 (45Hz).

Max AC Voltage, 10 min avg. This setting is only used in a Solar Hybrid system. For off grid systems set it to the maximum value of 264V. If the 10 minute average of AC Source Voltage goes above this value then the SP PRO will disconnect from the AC Source. The default of 255V is suitable for Australia. Set this to 248V for New Zealand.

Reconnect Delay In a Solar Hybrid system, the time the AC Source is in tolerance before re connecting to the grid. This delay does not apply to off grid or mobile systems. The defaults as shown are for Australia and NZ.

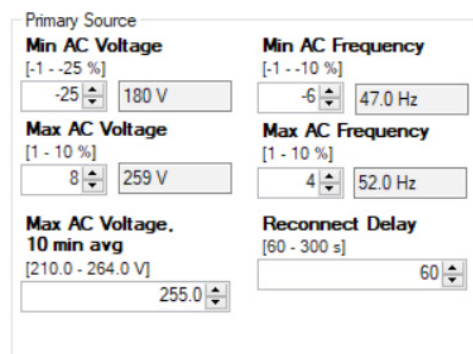

This close-up screenshot shows the 'Primary Source' settings. The 'Min AC Voltage' is set to -25% (180 V), 'Max AC Voltage' is set to 10% (259 V), 'Max AC Voltage, 10 min avg' is set to 255.0 V, 'Min AC Frequency' is set to -6% (47.0 Hz), 'Max AC Frequency' is set to 4% (52.0 Hz), and 'Reconnect Delay' is set to 60 seconds.



ALTERNATIVE SOURCE. Configuration settings are used in place of the PRIMARY SOURCE settings and the AC Source Power setting (in Quick Start section). The SP PRO uses these settings when running a backup generator in a Solar Hybrid system, a second generator in an Off Grid system or shore power in a mobile installation.

The Alternative Source is selected when the configured digital input is active. The digital input is configured using the Normal/Alternate Input Power Selector parameter in the Inputs/Outputs section.

If a backup generator is required in a Solar Hybrid (On Grid) system, the optional Grid Fail Generator Backup Module will need to be installed.

Alternate AC Source Power sets the capacity of the Alternative AC Source. If the alternative AC Source is a generator then set this to its continuous power rating. If the Alternative AC Source is shore power then set this to the rating of the shore power outlet.

Min AC Voltage AND **Max AC Voltage**. These parameters are set as a percentage of the Nominal AC Voltage setting (under the Inverter tab). If the AC Source voltage goes outside these limits the SP PRO will immediately disconnect from the AC Source.

Min AC Frequency AND **Max AC Frequency**. The parameters are set as a percentage of the Nominal AC Frequency setting (under the Inverter tab). If the AC Source frequency goes outside these limits the SP PRO will immediately disconnect from the AC Source.

Extern. Contactor/CT. If a pass through current of greater than 63AAC (125AAC SPLC1200 and SPLC1202) is required then this setting is enabled when an external contactor and current transformer of up to 1000AAC is installed. The current rating of the external current transformer is entered in **External CT**.

See separate Installation instructions TN0057 available from the web site under the Support tab.

The AC INPUT LOGGING is a Quality of Service monitoring function which sets the **Peak Voltage** threshold at which the inverter will record a performance data event. (Peak Voltage of AC rather than RMS - 240V AC has a peak voltage of 340 V)

If you have particularly sensitive loads such as computers and plasma TVs, you may choose to set this to a low value to monitor power quality and record any unexpected high voltages coming from external supply sources.

Alternative Source
Alternate AC Source Power
[0.4 - 217.4 A]
9.6 A

Min AC Voltage
[-1 - -30 %]
-10 216 V

Max AC Voltage
[1 - 10 %]
10 264 V

Min AC Frequency
[-1 - -10 %]
-10 45.0 Hz

Max AC Frequency
[1 - 10 %]
10 55.0 Hz

External Current Transformer
Extern. Contactor/CT
Disabled

External CT
[50 - 1000 A]
50 A : 5 A

AC Input Logging
Peak Voltage
[120 - 140 V]
130 441 V



Power Quality / DRM

Used to set the Power Quality modes and configure the DRM interface for compliance with AS4777.2-2015. These settings are only available for Grid Connected Systems.

The **Grid Voltage Power Reduction** modes and the **Export Power / Freq Watt Response** mode are enabled by default. Other Power Quality modes and DRM to be Enabled as required by the connected Network.

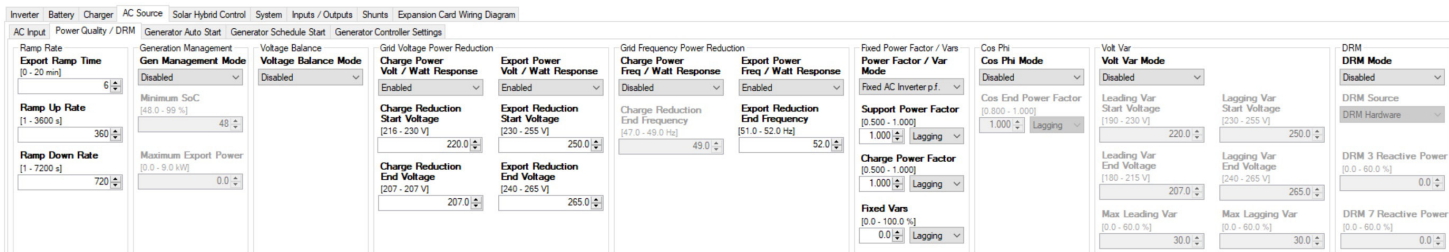

Export Ramp Time. This is a legacy setting that is replaced by Ramp Up Rate.

Ramp Up Rate applies to all of the Power Quality and DRM modes. The ramp up time is the time it takes for the export power or the battery charge power from the grid to ramp from zero to full power.

For charge power from the grid, full power is the rating of the SP PRO. For export power, full power is the export power limit of the SP PRO.

Ramp Down Rate only applies to Generation Management and is the rate at which the SP PRO will use battery power to limit the drop in export power.

Generation Management Mode will limit the rate of change of export power to the grid to be no faster than the **Ramp Up Rate** and **Ramp Down Rate** settings.

When the battery charge drops below **Minimum SoC**, export will be prohibited as there will not be enough energy in the battery for a ramp down event. **Minimum SoC** is limited according to the **Battery Capacity**, **Shutdown SoC** and **Ramp Down Rate**.

Maximum Export Power is set to equal the maximum capacity of the installed PV solar.

Voltage Balance Mode is normally disabled where the power quality modes are required to operate evenly across all phases in a three phase system. When enabled, the power quality modes will operated independently on each phase thereby improving the balance between the phase voltages.

Charge Power Volt / Watt Response will limit the amount of power that can be taken from the grid to charge the battery bank when the grid voltage drops below the **Charge Reduction Start Voltage**. As the grid voltage reduces, the charge power limit will linearly reduce, and reach zero when the grid voltage is less than or equal to the **Charge Reduction End Voltage**.

Export Power Volt / Watt Response will limit the amount of export power when the grid voltage rises above the **Export Reduction Start Voltage**. As the grid voltage rises, the export power limit will linearly reduce, and reach 20% of maximum export power when the grid voltage is greater than or equal to the **Export Reduction End Voltage**.

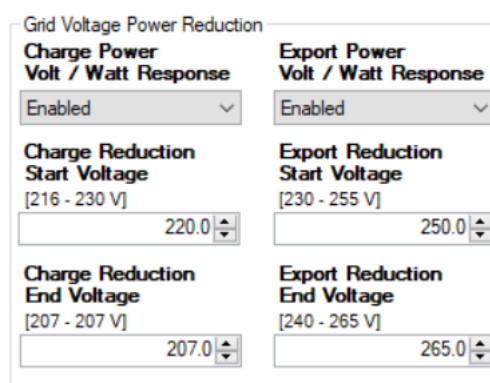
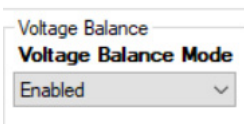
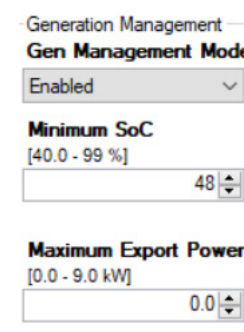
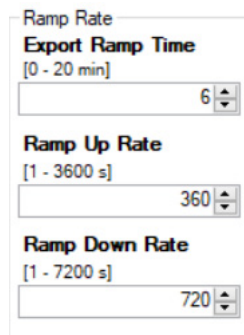



Charge Power Freq / Watt Response will limit the amount of power that can be taken from the grid to charge the battery bank when the grid frequency drops below 49.75Hz. As the grid frequency reduces, the charge power limit will linearly reduce, and reach zero when the grid voltage is less than or equal to the **Charge Reduction End Frequency**.

Export Power Freq / Watt Response will limit the amount of export power when the grid frequency rises above 50.25Hz. As the grid frequency rises, the export power limit will linearly reduce and reach zero when the grid frequency is greater than or equal to the **Export Reduction End Frequency**.

Both of the Grid Frequency Power response modes have hysteresis, meaning that the reduction in power won't recover as the frequency recovers. In both cases, the power will ramp back at the **Ramp Up Rate** 60 seconds after the grid frequency returns to normal.

Grid Frequency Power Reduction

Charge Power Freq / Watt Response	Export Power Freq / Watt Response
Enabled	Enabled
Charge Reduction End Frequency [47.0 - 49.0 Hz]	Export Reduction End Frequency [51.0 - 52.0 Hz]
49.0	52.0

REACTIVE POWER CONTROL

There are four modes that control the reactive power (Var output) of the SP PRO. Only the enabled mode with the highest priority will control the reactive power. The priorities from highest to lowest are:

DRM3 reactive power and **DRM7 reactive power** (only when DRM3 or DRM7 are active), **Volt Var Mode**, **Cos phi Mode**, **Power Factor / Var Mode**.

Power Factor / Var mode. The SP PRO will vary its Var output to provide either a fixed power factor or a constant Var output based on the **Power Factor / Var Mode** setting.

Power Factor / Var mode = Fixed AC Inverter p.f. (default setting)

This mode is used when the SP PRO is installed as a Solar Hybrid (grid connected) system and the inverter is required by the Utility to provide support power at a non-unity power factor.

Support Power Factor. Set the value of the required power factor and the phase of that power factor for when the SP PRO is supporting the load.

Charge Power Factor. Set the value of the required power factor and the phase of that power factor for when the SP PRO is charging the battery bank. Unless there is a special design requirement, this setting is left at 1.000.

Power Factor / Var mode = Fixed AC Source p.f.

This mode is used when the SP PRO is required to correct the power factor of the AC Source input. In this mode the inverter behaves much like a static compensator.

Export Power Factor. Set the value of the required power factor and the phase of that power factor when the SP PRO is exporting power to the grid. This setting would normally be used in special circumstances or as required by the utility.

Import Power Factor. Set the value of the required power factor and the phase of that power factor for when the SP PRO is drawing power from the AC Source terminals of the SP PRO (grid or generator). This function gives the ability for the SP PRO to power factor correct any power drawn from the grid or a generator and act like a static compensator.

Power Factor / Var mode = Fixed Vars

Constant Var Mode. The SP PRO will output a constant Var target equal to this setting as a % of the SP PRO power rating at 25°C

Fixed Power Factor / Vars

Power Factor / Var Mode

Fixed AC Inverter p.f.

Support Power Factor
[0.500 - 1.000]
1.000 Lagging

Charge Power Factor
[0.500 - 1.000]
1.000 Lagging

Fixed Vars
[0.0 - 100.0 %]
0.0 Lagging

Fixed Power Factor / Vars

Power Factor / Var Mode

Fixed AC Source p.f.

Fixed Power Factor / Vars

Power Factor / Var Mode

Fixed Vars

Cos Phi Mode changes the power factor of the export power from unity to **Cos End Power Factor** as the export power increased from 50% to 100% of the maximum export power limit of the SP PRO.

Cos Phi

Cos Phi Mode

Enabled

Cos End Power Factor

[0.800 - 1.000]

0.800 Lagging

As the grid voltage falls below the **Leading Var Start Voltage**, the vars generated by the inverter start to increase. This normally has the effect of increasing the grid voltage in a weak grid.

As the grid voltage rises above the **Lagging Var Start Voltage**, the vars absorbed by the inverter increase. This normally has the effect of reducing the voltage in a weak grid.

Max Leading Var and **Max Lagging Var** are the vars produced by the inverter when grid voltage reaches **Leading Var End Voltage** and **Lagging Var End Voltage** respectively, and are entered as a percentage of the 25°C power rating of the SP PRO.

Volt Var

Volt Var Mode

Enabled

<p>Leading Var Start Voltage</p> <p>[190 - 230 V]</p> <p style="text-align: right;">220.0 <input type="text" value="v"/></p>	<p>Lagging Var Start Voltage</p> <p>[230 - 255 V]</p> <p style="text-align: right;">250.0 <input type="text" value="v"/></p>
<p>Leading Var End Voltage</p> <p>[180 - 215 V]</p> <p style="text-align: right;">207.0 <input type="text" value="v"/></p>	<p>Lagging Var End Voltage</p> <p>[240 - 265 V]</p> <p style="text-align: right;">265.0 <input type="text" value="v"/></p>
<p>Max Leading Var</p> <p>[0.0 - 60.0 %]</p> <p style="text-align: right;">30.0 <input type="text" value="v"/></p>	<p>Max Lagging Var</p> <p>[0.0 - 60.0 %]</p> <p style="text-align: right;">30.0 <input type="text" value="v"/></p>

DRM Mode allows the charge power from the grid and the grid export power to be controlled by a DRED device. See AS4777.2-2015 for more details. All DRM modes are available.

DRM Source allows the DRM to be controlled by a DRED device plugged into the SP PRO DRM socket (DRM Hardware) or by a software interface allowing the DRM function to be controlled by writing directly to the SP PRO DRM memory location (DRM Memory).

DRM 3 Reactive Power. When DRM 3 is active, the SP PRO will source reactive power as a percentage of the SP PRO's 25°C power rating, according to this setting.

DRM 7 Reactive Power. When DRM 7 is active, the SP PRO will sink reactive power as a percentage of the SP PRO's 25°C power rating, according to this setting.

DRM

DRM Mode

Enabled

DRM Source

DRM Hardware

DRM 3 Reactive Power

[0.0 - 60.0 %]

0.0

DRM 7 Reactive Power

[0.0 - 60.0 %]

0.0



The Power factor / Var settings are from the Network's perspective.



Generator Auto Start

The use of an auto start generator in an Off Grid system is essential as a backup energy source in times of poor Renewable Energy production. In an Solar Hybrid (ON Grid) system the installation of an auto start generator can also provide excellent backup in times of extended outages without the need for oversized battery bank. This section explains how to use the generator to maximise battery life whilst obtaining the lowest operating costs on the system. The Generator Auto Start tab enables you to change the conditions under which the generator will start and stop. When a generator is started it will give first priority to service the AC Loads and any leftover available generator capacity will be used to charge the batteries.

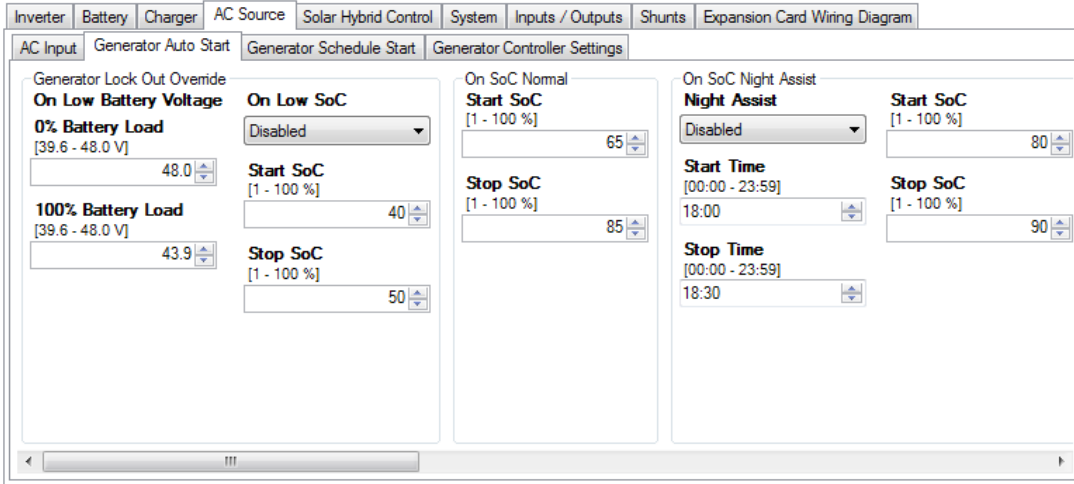

GENERATOR LOCK OUT OVERRIDE

On Low Battery Voltage: As a safety net the SP PRO will always start the generator based on battery voltage, regardless of the battery SoC or the status of the Generator Lockout. When the battery voltage drops below the **On Low Battery Voltage** settings it normally means that there is a problem with the battery bank and it needs a full charge The generator will start and run until the battery reaches FLOAT at which point the battery should have recovered and the battery SoC return to 100%.

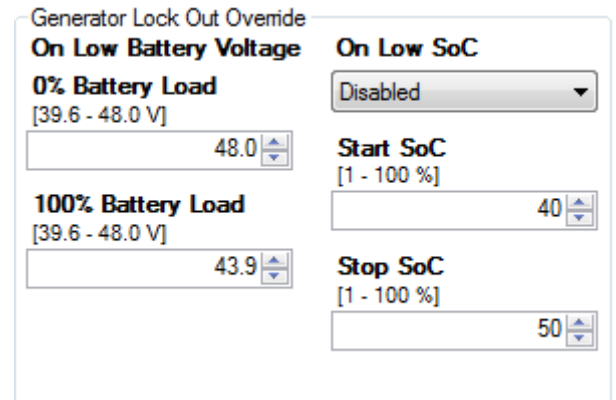

On Low SoC: When the **On Low SoC** is enabled and the state of charge falls below **Start SoC** at any time during the GENERATOR LOCK OUT period the generator will start and run until the SoC reaches **Stop SoC** or at the least for the Generator Minimum Run time.

The ON SoC NORMAL setting applies at times other than when other SoC Start Stop functions are active including during Generator Lock Out times. If SoC falls below **Start SoC**% the generator will be started and will charge until **Stop SoC**% or for Generator Minimum Runtime if **Stop SoC**% is reached before the minimum runtime has elapsed. By not allowing the generator to take the batteries to 100% avoids the generator from being too lightly loaded as batteries become full. It is more efficient to allow Renewable sources to fill the batteries to 100%

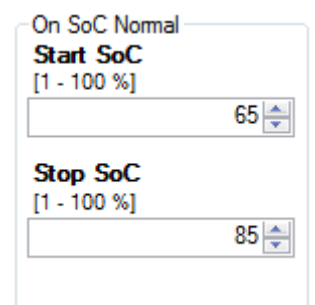



The ON SoC NIGHT ASSIST state of charge control monitors the State of Charge through the highest usage period, usually during the evening. If the battery level has dropped to the **Start SoC** level at the appointed time (between the **Start Time** and the **Stop Time**) the SP PRO will start the generator and raise the state of charge until the batteries reach the **Stop SoC** level. This prepares the system for the night ahead.

On SoC Night Assist

Night Assist

Start SoC
 [1 - 100 %]

Start Time
 [00:00 - 23:59]

Stop SoC
 [1 - 100 %]

Stop Time
 [00:00 - 23:59]

ON SoC RENEWABLE PREFERRED is designed to monitor the input from the solar array and, on a day when the renewable sources may be low in output, on a cloudy day or a day with no wind, start the generator at a lower state of charge to ensure the batteries do not get too low. This setting allows you to set a **Start SoC** percentage and a **Stop SoC** percentage that will keep the batteries in a “safe” state of charge.

On SoC Renewable Preferred

Renewable Preferred

Start SoC
 [1 - 100 %]

Start Time
 [00:00 - 23:59]

Stop SoC
 [1 - 100 %]

Stop Time
 [00:00 - 23:59]

If the solar input does not meet the usual consumption level you can start the day with a compensating charge that will enable the normal solar input to fully charge the batteries.

On SoC Renewable Assist

Renewable Assist

Start SoC
 [1 - 100 %]

Start Time
 [00:00 - 23:59]

Stop SoC
 [1 - 100 %]

Stop Time
 [00:00 - 23:59]



The combination of all these settings should give you a battery protection program that should look something like this.....

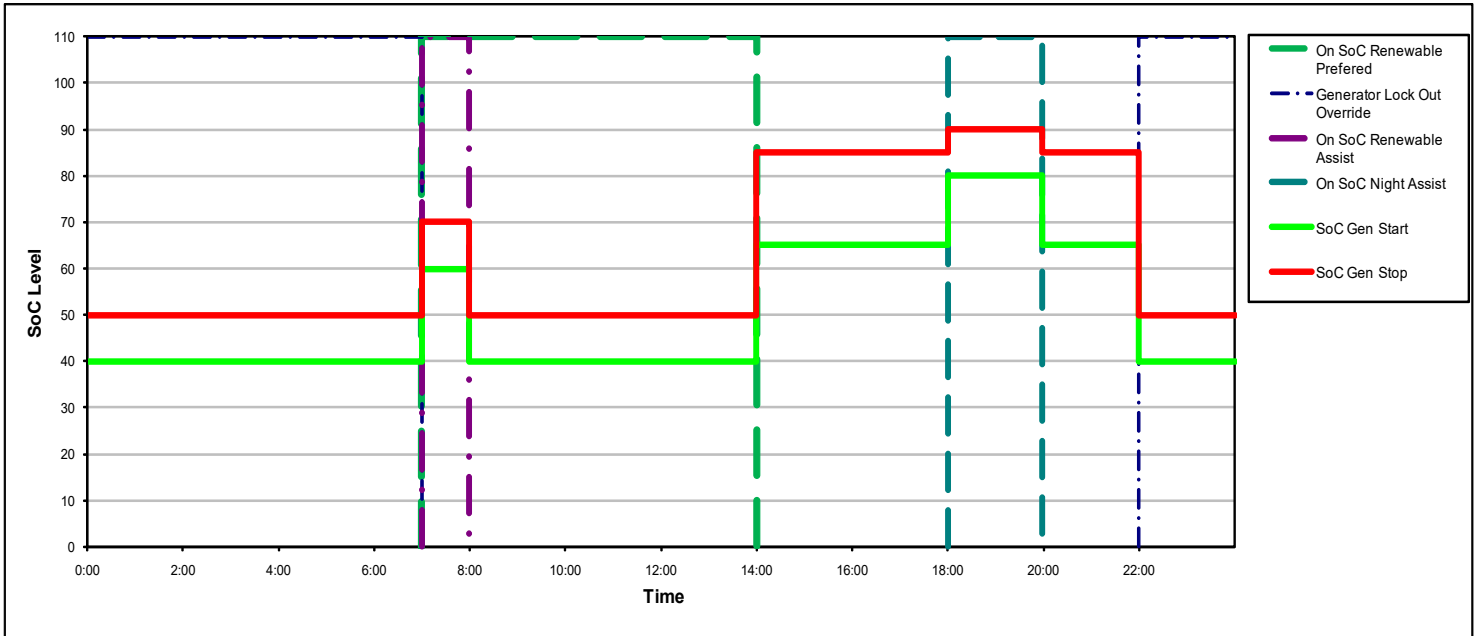

When you get up in the morning, before the solar panels are working at their best, the generator runs for an hour or so while you are cooking, or heating the bathroom for the kids, and starts the day with a support charge (see SoC Renewable Assist).

Then it shuts down during the day when you expect that the solar panels will be carrying the load; then it may start again later that night when the night load is at its highest or if there has been a cloudy day and there hasn't been as much solar input as you would have expected.

Throughout the whole day there is always the lower Generator Lockout Override "safety net" level that will not allow the batteries to get totally flat. An Accredited Installer can help you arrive at the most fuel efficient program to suit your particular needs.

The above system of Generator Auto Start SoC Start and Stop levels prevents the generator from charging the battery bank during the batteries least energy efficient stage; the highest voltage with the least amount of absorbed amp hours. This reduces the generator run time, saving fuel.

This type of system is called Partial SoC control. A battery system will perform well in partial SoC conditions however it is desirable to periodically fully charge a battery bank and bring the SoC to 100% by allowing the charger to complete through to Float stage.

Referring to the section FOR 100% SoC, if **Override Stop SoC** is enabled then during the Normal or Night Assist times, the generator will continue to run and charge the batteries right through to Float stage. This will occur according to the **Occurs Every** setting. In this example it occurs every 7 days.

For 100% SoC

Override Stop SoC

Disabled ▾

Occurs Every

[1 - 100 d]

7 ▾

The generator will also start if there is a persistent load on the batteries. **Battery Load** sets the level at which the generator will be started if the average load exceeds the preset level for more than 5 minutes.

Battery Load is the actual power being drawn from the battery bank. For example, if say solar is providing all the power to the site load, then no power will be coming from the battery bank i.e. Battery Load is 0 kW and the generator won't be started.

On 15 min Load is similar to the previous screen except the settings take effect if the average load exceeds the preset **Battery Load** limit for more than 15 minutes.

We previously discussed mid point monitoring and its ability to help determine a battery fault. This screen allows you to choose if a mid point **Voltage Error** should start the generator. The generator will then perform a full charge of the battery bank and if equalise is enable will perform an equalise charge.

Other Generator Start - Inverter Shutdown

To prevent system loss of power, the SP PRO will start the generator when it is about to shutdown from either overload or low battery charge conditions.

If the generator starts because the SP PRO is about to shutdown from low battery voltage then it normally means that there is a problem with the battery bank and needs a full charge. The generator will start and run until the battery reaches FLOAT at which point the battery should have recovered and the battery SoC return to 100%.

If the generator starts from any other inverter shutdown or imminent shutdown reason then the generator will run until the shutdown condition is cleared or the minimum generator run time.

On 5min Load

5 Min Load

Disabled ▼

Battery Load
[0.2 - 15.0kW]

4.0 ▲▼

On 15min Load

15 Min Load

Disabled ▼

Battery Load
[0.2 - 65.0 kW]

3.0 ▲▼

On Mid Point

Voltage Error

Enabled ▼



Generator Schedule Start

Some people have predictable times when they require a generator to run, such as when a regular plant watering routine requires pumps to run, the program contains the ability to predetermine four different schedules.

Each of the four Schedules (specified as Sched. x in the following examples) can be enabled or disabled.

Using **Sched. x Day** you can choose a day of the week, all weekdays, all weekends or everyday (All).

A Sched. x Start Time

Schedule 3

Disabled ▾

Sched. 3 Day

All ▾

Sched. 3 Start Time*
[00:00 - 23:59]

05:00 ▾

Sched. 3 Stop Time
[00:00 - 23:59]

00:00 ▾ Enabled ▾

And a Sched. x Stop Time

The **Sched. x Stop Time** can be enabled or disabled. If the stop time is enabled the SP PRO will automatically turn off the generator at the end of the scheduled time or, if disabled, the generator will continue to run if a full charge cycle has not been completed or until all other generator turn off criteria have been met.

Schedule 4

Disabled ▾

Sched. 4 Day

All ▾

Sched. 4 Start Time
[00:00 - 23:59]

00:00 ▾

Sched. 4 Stop Time*
[00:00 - 23:59]

22:00 ▾ Enabled ▾

Enabled
Disabled

As an example, lets imagine you run a yoga class every Saturday morning and you wish to run a reverse cycle air conditioner for the period of the lesson. You may choose to run the generator during this period to prevent stress on the batteries. In this case the schedule would look like this.

Run Schedule

Schedule 1*

Enabled ▾

Sched. 1 Day*

Saturday ▾

Sched. 1 Start Time*
[00:00 - 23:59]

09:00 ▾

Sched. 1 Stop Time*
[00:00 - 23:59]

12:00 ▾ Enabled ▾



INVERTER UNAVAILABLE SCHEDULE.

This is a legacy setting and is not available with Powerchain features..

Inverter Unavailable Schedule

Schedule 1	Schedule 2	Schedule 3	Schedule 4
Disabled	Disabled	Disabled	Disabled
Sched. 1 Day	Sched. 2 Day	Sched. 3 Day	Sched. 4 Day
All	All	All	All
Sched. 1 Start Time [00:00 - 23:59]	Sched. 2 Start Time [00:00 - 23:59]	Sched. 3 Start Time [00:00 - 23:59]	Sched. 4 Start Time [00:00 - 23:59]
00:00	00:00	00:00	00:00
Sched. 1 Stop Time [00:00 - 23:59]	Sched. 2 Stop Time [00:00 - 23:59]	Sched. 3 Stop Time [00:00 - 23:59]	Sched. 4 Stop Time [00:00 - 23:59]
00:00	00:00	00:00	00:00

Generator Control Settings

The last tab in the AC Source section is the Generator Controller Settings

If there is an automatic generator permanently connected to the system the **Generator Controller** setting should be set to Enabled. This is highly recommended for OFF Grid systems. If there is no automatic generator connected it should be Disabled.

The **Auto Start Available** control allows 2 states. Follow Input allows you to switch the generator availability on and off with an input signal (normally 12 volts from the generator). This ensures that the SP PRO will not try to start the generator if it has become unavailable, e.g. starter battery flat or generator maintenance is being performed. Assume Always allows the inverter to operate as if the generator is always available.

Minimum Runtime determines the shortest time the generator will run. This is to ensure the generator won't start and stop too frequently.

The **Pre-synchronised warm Up Time** is the length of time, after the generator starts, before the generator is connected (Transferred) to any load. This is then followed by the **Warm Up Time**, the length of time, after the **Pre-synchronised warm Up Time**, before a charging sequence starts. Once synchronised, the AC Load is transferred to the generator during the **Warm Up Time**. The staged warm up sequence allows the generator to circulate the oil within the motor thoroughly and to allow the motor to reach operating temperature before being heavily loaded by the charger.

Cool Down Time disconnects the load from a generator for a period of time before shutdown to allow turbochargers to cool down before switching off. The **Cool Down Time** is overridden if generator is stopped using front panel push button.

Generator Lock Out provides a "quiet time" when the generator will not run unless the batteries get to a dangerously low level as set in the Generator Lockout Override ("Generator Auto start" tab). This setting is generally used for overnight operation.



If the system design calls for very little, or infrequent generator input it is wise to run the generator periodically to keep the internal parts of the motor covered with oil and to keep the starting battery charged.

To use this feature Enable **Generator Exercise** and enter the **Start Time** the generator will run. **Max Days** determines how many days between generator starts. In this example the generator would start 30 days after the last time the generator was called for, would start at 18:00 and would run for the period set in Minimum Runtime.

Generator Exercise

Generator Exercise

Disabled ▾

Start Time
[00:00 - 23:59]
18:00 ▾

Max Days
[1 - 100 d]
30 ▾

GENERATOR REMAIN ON is feature allows you to determine the minimum load will keep the generator running after a stop condition has been achieved, thus avoiding significant battery discharge. This term is expressed as a percentage of the inverter rating at 40C ambient.

In this example the inverter rating at 40C ambient is a 6 kW and **AC Load (50 - 100%) of rating** is set to 80%. Therefore whilst the load on the system exceeds 4.8 kW (80% of 6kW) the generator will continue to run.

Generator Remain on

AC load (50 - 100 %) of rating
[50 - 100 %]
80 ▾

The **Start output Delay** setting determines the length of time after the generator run signal is initiated by the SP PRO, either by an external request, load requirement or by a battery charge requirement, before the generator start pulse is initiated.

Start output Time is the length of time a start pulse is sent. This output can be used in a pulse start/pulse stop type generator control.

Confirm start time is the time the SP PRO waits before deciding the generator hasn't started. The SP PRO will try a total of three times to get the generator running with a 60 second pause between each attempt.

Signal Timing

Start Output Delay
[0.5 - 30.0 s]
2.0 ▾

Start Output Time
[0.5 - 30.0 s]
2.0 ▾

Confirm Start Time
[15 - 120 s]
30 ▾

SIGNAL TIMING GRAPH The below graph depicts the relative timing for the Generator Run and the Generator Start signals.

When the generator is requested to start (A), the Generator Run signal is immediately asserted. After a delay equal to the **Start Output Delay** (A to B) the Generator Start signal is asserted (B) for a duration equal to the **Start Output Time** (B to C).

When the generator is requested to stop (D) the Generator Run signal is immediately de-asserted at the same time that the Generator Start signal is asserted for a duration equal to the **Start Output Time** (D to E).

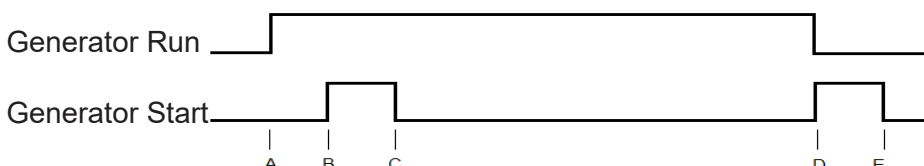

Solar Hybrid Control Settings

The Solar Hybrid Control settings are enabled when the Unit Application is set to Solar Hybrid (On Grid) and SoC Control is Enabled. They allow the system designer to determine when a defined amount of stored battery energy is utilised in conjunction with the connected renewable energy sources to optimise their use. Optimum use of the renewable and stored battery energy gives the SP PRO control over when and the amount of grid energy, if any, is required to power the connected loads. Using the settings below provides this flexibility.

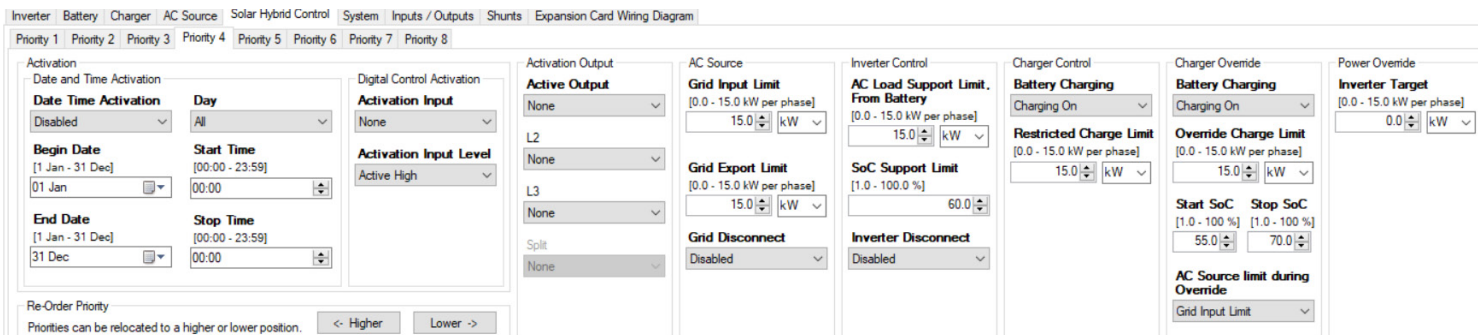

The screenshot shows a configuration interface with several panels:

- Activation:** Includes Date and Time Activation (Date Time Activation: Disabled, Day: All, Begin Date: 01 Jan, End Date: 31 Dec, Start Time: 00:00, Stop Time: 00:00) and Digital Control Activation (Activation Input: None, Activation Input Level: Active High).
- Activation Output:** Active Output: None, L2: None, L3: None, Split: None.
- AC Source:** Grid Input Limit: 15.0 kW, Grid Export Limit: 15.0 kW, Grid Disconnect: Disabled.
- Inverter Control:** AC Load Support Limit From Battery: 15.0 kW, SoC Support Limit: 60.0%, Inverter Disconnect: Disabled.
- Charger Control:** Battery Charging: Charging On, Restricted Charge Limit: 15.0 kW.
- Charger Override:** Battery Charging: Charging On, Override Charge Limit: 15.0 kW, Start SoC: 55.0%, Stop SoC: 70.0%.
- Power Override:** Inverter Target: 0.0 kW.

PRIORITY 1 to PRIORITY 8

The Solar Hybrid Control is made up of eight groups of identical settings with each assigned and labelled a priority level from 1 to 8 with priority 1 being the highest. If two or more Priority Schedules are active at the same time, only the highest priority settings will apply.

When a Priority schedule is active, all of its configuration options are active during that time. To see what Priority group is active and the limits that currently apply, see the SYSTEM REGULATION STATUS under the DATA VIEW NOW display..

The following configuration options are common to all of the Priority schedules

ACTIVATION controls when the limits and controls set for that Priority schedule become operational. ACTIVATION is divided into two sections:-

Enable Date and Time Activation setting. Use **Begin Date** and **End Date** to set the inclusive date range over which you want this Priority Schedule to be active. By default the range is all year and only requires adjustment if part of a year such as summer is required.

Day selects the days of the week (Mon, Tues, ..., Sat-Sun, Mon-Fri, All) when the schedule to be active.

Select the **Start Time** and **Stop Time** (in 24 hr format) for the schedule to be active. If the **Stop Time** is earlier than the **Start Time** then the **Stop time** is for the following day. If the following day is not selected in the Day or Date setting then the schedule will stop at midnight on the last selected day.

The digital input set in **Activation Input** is also used to activate the Priority schedule. This input will activate the Priority schedule regardless of the Date Time Activation. The priority will enable when input is high (Active High) or Low (Active Low).

Both Activation types (Date/time and Digital Control) can be used. If either is active then the Priority Schedule will be active.

During Activation, the output set in **Active Output** will be energised.

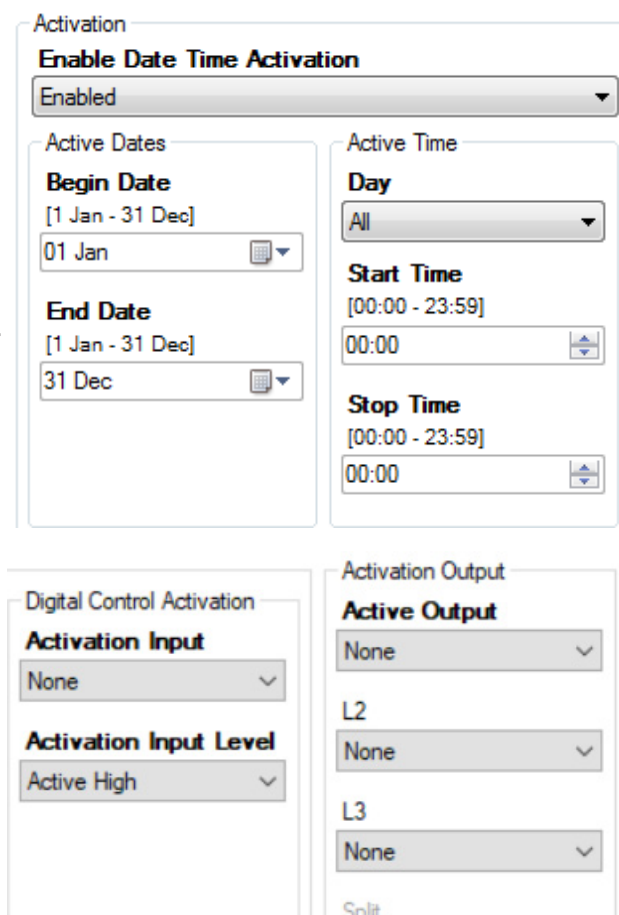

This detailed view shows the following settings:

- Activation:**
 - Enable Date Time Activation: Enabled
 - Active Dates:
 - Begin Date: [1 Jan - 31 Dec], 01 Jan
 - End Date: [1 Jan - 31 Dec], 31 Dec
 - Active Time:
 - Day: All
 - Start Time: [00:00 - 23:59], 00:00
 - Stop Time: [00:00 - 23:59], 00:00
- Digital Control Activation:**
 - Activation Input: None
 - Activation Input Level: Active High
- Activation Output:**
 - Active Output: None
 - L2: None
 - L3: None
 - Split: (label visible)



AC SOURCE controls the grid connection in three ways:-

Set the **Grid Input Limit** to the maximum draw from the grid supply. This limit will override the AC Source Power limit configured within the Quick Start settings. Any AC Load demand above this limit will be supplied from the Battery plus renewable energy sources (Battery / RE system).

This limit will only be breached if the AC Load demands more power than is available from the Battery / RE system or if the SoC Support Limit within the Priority schedule is reached.

Set the **Grid Export Limit** to the maximum power to be put into the grid. This limit will override the AC Source Power limit configured within the Quick Start settings.

This limit only applies to Managed AC Coupling or DC Coupled PV and must be set to the maximum (15kW for SPMC models and 30kW for SPLC models) when using Generic AC Coupled supply.

Enable **Grid Disconnect** to switch the SP PRO into standalone mode and operate completely on the Battery plus any renewable energy generation. No grid export or grid battery recharge is possible when the **Grid Disconnect** is Enabled

The **Grid Disconnect** setting will be overridden if the SoC Support Limit within the Priority schedule is reached or if Inverter Disconnect is Enabled.

The **Grid Disconnect** setting will be disabled and greyed out in all secondary inverters in a Powerchain configuration. Only the System Manager (L1 manager) controls this function.

INVERTER CONTROL manages the AC Load Battery Support by controlling the amount and limit of battery support.

AC Load Support Limit sets the maximum AC Load power that can be supported from the battery bank when the SP PRO is synchronised to the AC Source (Grid) supply. This power does not include any contribution from AC or DC Coupled PV.

This limit is overridden to zero when the SoC Support Limit is reached.

SoC Support Limit sets the minimum Battery SoC that the AC Load Support and AC Source control will operate to. When the **SoC Support Limit** is reached any discharge demand on the battery is diverted to the AC Source (Grid) supply. When the SoC recovers by 20% of the battery's discharge (e.g. back to 68% with a **SoC Support Limit** setting of 60%) then the **AC Load Support Limit** will once again apply.

Setting **Inverter Disconnect** to Enable switches the SP PRO into grid feed through mode and operate completely from the Grid and AC Coupled PV. No DC Coupled grid export, grid battery recharge or AC Load Support is possible during times when the **Inverter Disconnect** is Enabled.

The **Inverter Disconnect** setting will be overridden if the AC Source (Grid) supply falls outside AC voltage and frequency tolerance. There will be short break in supply (< 1.0 seconds) while the Inverter functions switches on-line to provide back-up power.

The **Inverter Disconnect** setting will be disabled and greyed out in all secondary inverters in a Powerchain configuration. Only the System manager controls this function.

AC Source

Grid Input Limit
[0 - 217.4 A]
208.3 A

Grid Export Limit
[0 - 217.4 A]
20.8 A

Grid Disconnect
Disabled

Inverter Control

AC Load Support Limit, From Battery
[0 - 50 kW]
15.0 kW

SoC Support Limit
[1 - 100 %]
60

Inverter Disconnect
Disabled

CHARGER CONTROL restricts the total AC power level and all the AC Sources (if any) from which the battery is being charged. The settings under Charger Control are active until the Battery SoC drops to the **Start SoC** setting under Charger Override, at which point the settings under Charger Override become active. The Charger Override settings will remain active until the battery SoC reaches the **Stop SoC** setting.

The settings below apply to both the Charger Control and the Charger Override.

Battery Charging sets the charging source. The three options are:-

CHARGING ON: The SP PRO will comply with the requirements of the “Charger” Settings unless they exceed the **Restricted Charge Limit** setting. If the rating of the inverter is less than the **Restricted Charge Limit** setting then the inverter’s rated charge power will apply. This will reduce as temperature of SP PRO increases. The Grid Input Limit setting can also affect the charge power as this cannot be exceeded when charging from the grid.

In summary the max charge power is the lesser of the following:

- The Charger settings limit.
- The **Restricted Charge Limit** setting
- The inverter Charge power rating (temperature dependent).
- Available power from all charging sources (Grid Input Limit – Load power + renewable Power).

The Charge Limit is displayed in the Data View > Now tab and is the lesser of:

- The **Restricted Charge Limit** setting
- The inverter Charge power rating (temperature dependent).

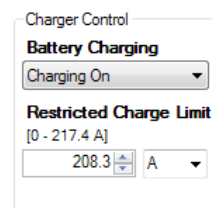

RENEWABLE ONLY: The SP PRO maximum charge power will be the lesser of the following limits.

- The Renewable Power available for charging = Renewable – Load power
- The Charger settings limit.
- The **Restricted Charge Limit** setting
- The inverter Charge power rating (temperature dependent).

The Charge Limit is displayed in the Data View > Now tab and is the lesser of:

- The Renewable Power available for charging = Renewable – Load power
- The **Restricted Charge Limit** setting
- The inverter Charge power rating (temperature dependent).

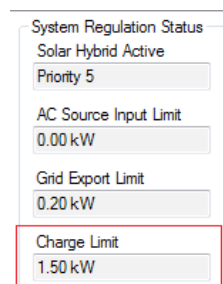

It should be noted that CHARGING ON setting with a Grid Input limit of 0kW operates the same as Renewable Only. This is because nothing can come from the grid during charging so charging can only come from renewable sources.

CHARGING OFF: Battery recharging disabled. This option will be overridden by any DC coupled solar charging sources when the AC Source (Grid) is disconnected or the Inverter is disconnected. It will be overridden by any Generic AC coupled sources when the AC Source (Grid) is disconnected.

CHARGER OVERRIDE settings become active instead of the Charger Control settings when the Battery SoC transitions down through the **Start SoC** setting. They revert back to the Charger Control settings when the Battery SoC transitions up through the **Stop SoC** setting. **Override Charge Limit** settings have the same function as the **Restricted Charge Limit** settings.

AC Source limit during Override allows an alternative AC Source limit to be used when the battery Charging is in Charger Override.

Selecting **Grid Input Limit** (default value) means there will be no change to the AC Source Limit during Charger Override.

Selecting **AC Source Power** means that the AC Source Limit will change to the AC Source Power setting in the Quick Start section under the Configurations Settings tab.

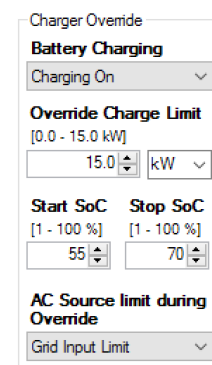

POWER OVERRIDE only operates when the **Allow Power Override** is enabled in the Installer Only Service settings. When set, the SP PRO exports a constant power from the battery bank into its AC output port. (feeds the AC loads then exports any excess to the grid).

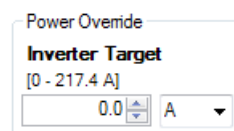



System Settings

In this section we will look at how the SP PRO works with the whole system. Whether the SP PRO will automatically recover from system faults, how it will alert you of problems and how it links with the computer and other communication devices.

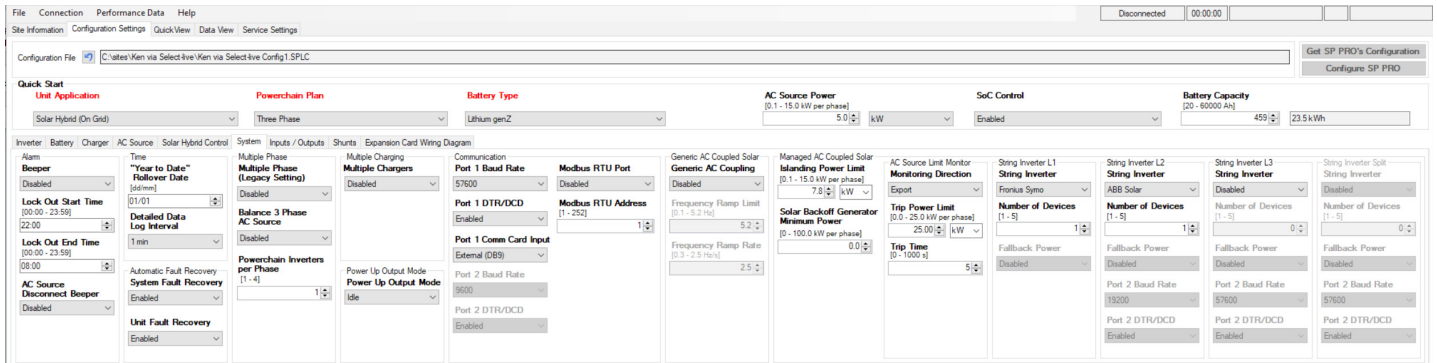

The SP PRO is configured to recognise, and report, a number of events that can cause damage to the system, such as overloads, low voltage batteries. These events can be announced by a beeper within the SP PRO.

The Alarm - **Beeper**, may be set to Enabled - Beeper will activate at any time or Locked Out - Beeper will not activate during the Lock Out period. Set a **Lockout Start Time** and a **Lockout End Time**.



Beeper will activate after lock out if existing alarm still persists. Disabled - Beeper will not sound for any alarms.

The **AC Source disconnect beeper** provides an alert signal (five short beeps), once per minute, if the SP PRO is not synchronised to the AC Source. This is disabled by default and must be Enabled if you wish the system to signal that it is running on battery supply during grid outages.

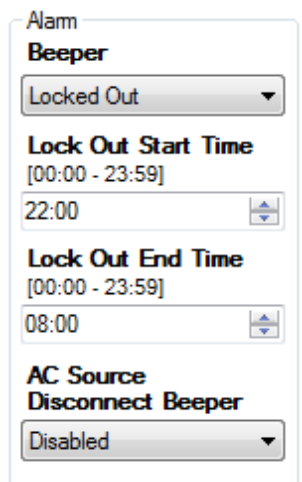

The Year to Date feature of the unit is used to monitor the systems performance on an annual basis. You can choose the start date of that year with "**Year to Date**" Rollover Date. This could be the day you installed it, the first day of the year or another date that is relevant to the installation.

Through **Detailed Data Log Interval** you can choose how often an entry is made. A short interval of 1 minute will give more detailed information, but for only four days. A long interval of 30 minutes will give less detail but 120 days of records. A 15 minute setting records for 60 days and gives a good balance between detail and the number of days recorded.

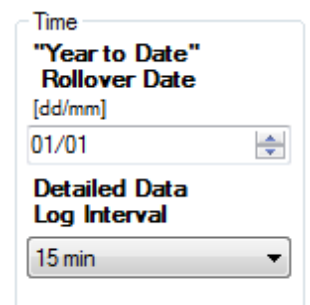

The SP PRO has the ability to automatically attempt to recover from a fault situation. If **System Fault Recovery** is enabled the SP PRO will monitor the situation that created the fault, such as low battery voltage, and return the inverter to operation if the battery voltage returns to a suitable level.

Similarly if **Unit Fault Recovery** is enabled an internal problem within the SP PRO, such as overheating, is monitored and normal operation continued if the problem is resolved.

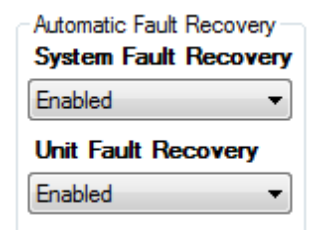

Multiple Phase is a Legacy setting for backward compatibility to older multiphase systems.

Balance 3 Phase AC Source only works with a three phase or split-phase Powerchain system and will attempt to balance the generator phases, regardless of any imbalance in the load power. The two settings will attempt to balance the phases within a percentage of the total generator capacity.

Powerchain Inverters Per Phase. Set automatically after assigning the SP PROs in the Powerchain Inverter Assignments tab. For example in a three phase system with 6 SP PROs there will be 2 Powerchain Inverters per phase.

Enable Multiple Chargers will help balance the charge current across the phases in a three phase or split-phase powerchain system.

Generic AC Coupling is only suitable for Solar Hybrid (On-Grid) systems and allows the grid connected solar to continue to supply power to the load and to charge the battery bank during a grid outage.

This setting allows the SP PRO to “kick off” or back off the power of any grid tie inverter that is connected to the AC Load side of the SP PRO by ramping the frequency of the AC output of the SP PRO. This AC Frequency ramp is triggered during a grid outage when the battery voltage or charge current rises above the SP PRO’s active charge voltage or current target. When the battery voltage or charge current drops below the battery charge target, the output frequency of the SP PRO will ramp back down.

Enabled - The frequency will ramp all the way to the Frequency Ramp Limit before ramping down again to the nominal Frequency.

MicroGrid - The frequency will start ramping down again as soon as the charge current and voltage fall below the SP PRO charge targets. This setting can be used when the AC coupled grid inverter is configured with a frequency/watt response, providing smoother control of the AC coupled grid inverter output.

Frequency Ramp Limit sets the maximum “Generic AC Coupling” ramp frequency above the “Nominal AC frequency”. For example if the Nominal AC frequency is 50 Hz and the Frequency Ramp Limit is set to 2.5, then the output frequency of the SP PRO will ramp to 52.5 Hz during a Generic AC Coupled frequency ramp.

Frequency Ramp Rate sets the rate of the “Generic AC Coupling” frequency ramp.

The ON front panel button is used to set the SP PRO to either IDLE (SP PRO is monitoring but providing no AC output) or ON (Inverter output is operating normally) By default, when the battery supply is connected, the SP PRO will power up in IDLE mode. With the **Power Up Output Mode** setting, this can be changed to power up in ON mode without having to press the ON button.

Multiple Phase Settings

Multiple Phase

L2-Secondary ▾

Balance 3 Phase AC Source

Balanced within 10% ▾

Powerchain Inverters per Phase

[1 - 4]

2 ▾

Multiple Charging

Enable Multiple Chargers

Disabled ▾

Generic AC Coupled Solar

Generic AC Coupling

Enabled ▾

Frequency Ramp Limit

[0.1 - 5.2 Hz]

5.2 ▾

Frequency Ramp Rate

[0.1 - 2.5 Hz/s]

2.5 ▾

Power Up Output Mode

Power Up Output Mode

Idle ▾



The SP PRO is designed to communicate with an external computer, either directly connected or via a communications device to a distant location.

There are two ports for this data transfer. When connecting through a modem DTR/DCD control signals allow the modem to signal the SP PRO that a modem connection has been established and when that connection has been dropped.

These control signals can be enabled through **Port 1 DTR/DCD** and **Port 2 DTR/DCD** while the speed of the data flow can be set with **Port 1 Baud Rate** and **Port 2 Baud Rate**.

When connecting directly with a computer through the USB port or data cables the **Port 1 Baud Rate** would normally be set at 57600 bps (default).

Note: Port 1 DTR/DCD is not supported and only provided for backward compatibility.

Modbus RTU Port. This interface provides the ability to read and write a number of parameters to the SP PRO.

The Modbus RTU port is only available in SP PRO inverters fitted with a communications card of hardware revision 8 and above.

Any SP PRO Series II or Series 2i can be retrofitted with a suitable communications card, available from Selectronic.

Please refer to OI0010_xx SP PRO MODBUS Access Interface available from the Selectronic web site

“Managed AC Coupled Solar” Section activates the AC coupled features within the SP PRO including the communications link with the Selectronic Certified grid inverter. The SP PRO Managed AC Couple Solar provides an efficient and convenient method of adding solar that is connected via the AC Bus.

Islanding Power Limit limits the output power of all the connected compatible solar inverters when the SP PRO is islanding or Off Grid. In a multi-phase system this setting is per phase. For example in a three phase system an Islanding Power Limit setting of 10kW will limit the total solar output for the system to 30kW when islanded. This parameter is useful in Solar Hybrid systems with small battery banks and allows the maximum amount of Solar to be installed and outputted when the system is connected to the grid because the SP PRO will reduce the maximum solar output to a safe level when islanded (during a grid outage).

This setting is automatically set based on the SP PRO model and battery size.

Solar Backoff Generator Minimum Power. This setting backs off the Managed AC coupled Solar to try and maintain a minimum generator output power. This is used with generators that have problems at low load power.

Monitoring Direction determines how the AC Source Limit Monitor operates. When **Monitoring Direction** is Export, and the exported power to the grid is greater than **Trip Power Limit** for the **Trip Time**, the SP PRO signals the managed AC coupled grid inverters to turn off. Setting these limits to suit the requirements of the connected utility will ensure they are never exceeded.

When **Monitoring Direction** is Import, and the power drawn from the grid or Generator is less than **Trip Power Limit** for the **Trip Time**, the SP PRO signals the managed AC coupled grid inverters to turn off. This setting is useful in off grid systems to maintain a minimum load on the generator or grid connected systems where the utility requires a minimum draw from the grid.

Communication

Port 1 Baud Rate
57600

Port 1 DTR/DCD
Enabled

Port 2 Baud Rate
9600

Port 2 DTR/DCD
Enabled

Modbus RTU Port
Disabled

Modbus RTU Address
[1 - 252]
1

Managed AC Coupled Solar

Islanding Power Limit
[0.1 - 15.0 kW per phase]
15.0 kW

Solar Backoff Generator Minimum Power
[0 - 100.0 kW per phase]
1.0

AC Source Limit Monitor

Monitoring Direction
Import

Trip Power Limit
[0.0 - 250.0kW]
0.50 kW

Trip Time
[0 - 1000 s]
1

String Inverter selects the brand of Selectronic Certified grid inverter(s) that are connected to the SP PRO in the Managed AC coupled system. Only one brand of grid inverter may be connected to the SP PRO although any mix of compatible models within that brand may be used.

The SP PRO firmware comes in four versions based on the Selectronic Certified grid inverters installed. Powador, ABB Solar, Fronius and Select Sun. If the firmware within the SP PRO does not support the configured **String Inverter** then SP LINK will go to the Firmware Update screen ready to update to the correct version of firmware. See **Firmware Update** on page 27.

In a Powerchain configuration, different brands of string inverters may be configured for each phase manager. However each phase manager may only have one brand of inverter.

At least one String Inverter must be configured on the System Manager (L1 phase manager) before any String inverters are configured on the L2 and L3 phase managers.

When a three phase Powerchain system is configured, three phase Selectronic Certified string inverters may be used, being the Fronius Symo and the SelectSun. Up to five three phase string inverters may be configured on each phase manager giving a maximum of fifteen (15) string inverters per system.

Number of Devices sets the number of compatible inverters that are connected to the SP PRO in a Managed AC Coupled system. The maximum number of units per phase manager is five.

L1

String Inverter

Fronius Primo ▼

Number of Devices
[1 - 5]

1 ▲▼

Fallback Power

Disabled ▼

L2

String Inverter

Disabled ▼

Number of Devices
[1 - 5]

0 ▲▼

Fallback Power

Disabled ▼



Please ensure that the combined AC output of all connected Selectronic Certified grid inverters does NOT exceeding twice the AC Power output rating of all of the SP PROs in the Powerchain system (some exceptions apply based on battery size - Run the Site configuration wizard to verify your design).



Kaco string inverters may not be used in a Powerchain system that has more than one SP PRO per phase (a system with managers only. No workers)

Fallback Power. Only used with KACO Powador 00 or 02 series inverters built in 2014 or later. See “IN0018_xx SP PRO KACO Managed AC Coupling Installation Notes”

For more detailed information on Managed AC coupling please refer to the installation notes found on the web site at www.selectronic.com.au



Input and Output Settings

The inverter contains 4 digital inputs, 4 relay outputs, 2 analogue inputs (excluding 120 V models) and 3 digital outputs, and these form the heart of the flexibility and sophistication of the SP PROs interface with the outside world.

With these controls you can monitor when various set points are reached, switch on appliances when certain criteria are met, protect the generator from damage due to low oil pressure, schedule a watering system to switch on and off and many other functions.



Maximum voltage to any input or output; 60 VDC. See SP PRO specifications for full details.

DIGITAL INPUTS IN A POWERCHAIN SYSTEMS. Only the digital inputs on the System Manager inverter L1 are enabled. The state of a digital input on L1 automatically sets the digital inputs on all other phases.

DIGITAL OUTPUTS IN A POWERCHAIN SYSTEMS. Most of the digital outputs can be enabled individually for each of the phase managers as shown in the applicable setting.

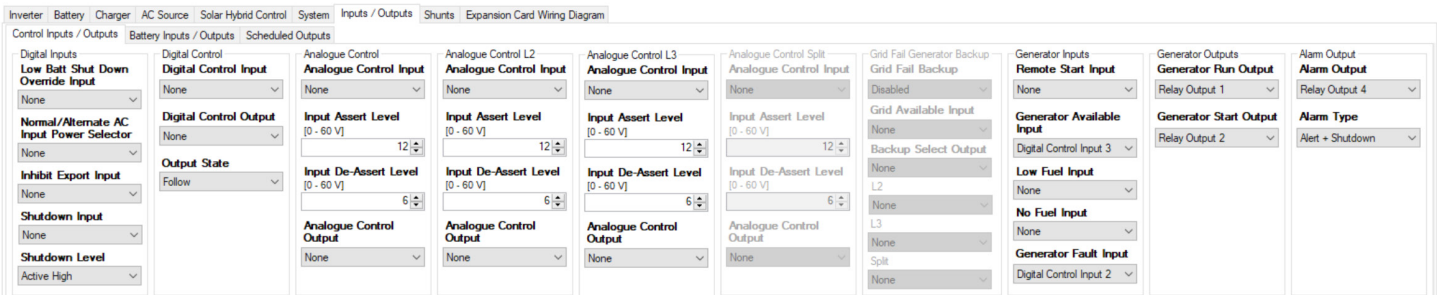

Low Batt Shutdown Override Input function is also known as the “Just Go” control. In case of emergency, even if the batteries would normally be considered too flat to safely run the inverter, activating this input will force the inverter to run, until there is insufficient battery power left to maintain the load. This is considered essential if, say, phones or a fire pump MUST be operated.

Normal/Alternate AC Input Power Selector. When a second AC Source with a different capacity to the primary AC Source (Normal), is available to the system, use this setting to set the input that you wish to use to select the alternate power level. The alternate source power level is configured in Alternative AC Source Power back in the AC Input section. When Alternate is selected, Solar Hybrid Control Priority schedules are overridden and no longer apply.

Inhibit Export Input. In some circumstances you may wish to prevent the SP PRO from exporting excess energy to the AC Source such as when the grid has failed and you have connected a diesel generator into the system. Used in conjunction with the Normal/Alternate AC Input you can switch to a different power level and know that the SP PRO will not try to export power to the motor generator.

Shutdown Input, when active, will turn off the inverter section of the SP PRO and prevent any charging or discharging of the battery bank. Driving this input from the warning output of a Battery Management Systems (BMS) will provide a failsafe shutdown of the inverter. For Off Grid systems with auto start generators, the generator will start whilst this input is active and restore power to the site.



When the SP PRO is integrated with a managed battery (e.g. BYD), and there is a serious BMS fault within the battery system, the SP PRO will shut down as if this input was activated.

Shutdown Level selects the level at which the Shutdown Input is active

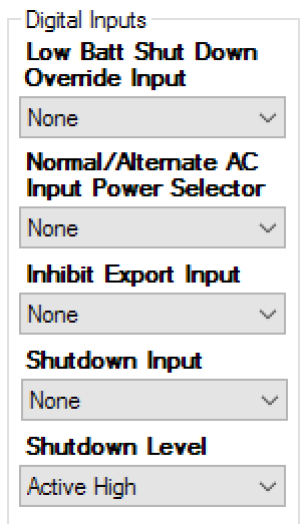

The DIGITAL CONTROL section is used to switch an output on or off with a digital input. For example, if the input that is set in **Digital Control Input** setting (Digital Input 2 in the example) is activated then the output set in **Digital Control Output** will be controlled (Relay Output 4 in this example) The output can be reversed using the **Output State** setting. In the given example a positive input to Digital Control Input 2 from an upper float switch could switch off a water pump via Relay Output 4.

In short you can control many different types of appliances or warning devices from digital inputs.

The switching of a digital input is recorded as events on the event log and can be monitored by downloading data.

The SP PRO has two analogue inputs that can control the full range of output options. The analogue input is set in **Analogue Control Input**. An analogue input differs from a digital input in that instead of reacting to an on/off type signal as a digital input does. An analogue input reacts to a pre-programmed upper and lower voltage level which are set in **Input Assert Level** (on voltage point) and **Input De-Assert Level** (off voltage point).

As an example if a suitable moisture sensor was connected to Analog Input 1 the output from Relay Output 3 could be used to switch a watering system on and off depending on the moisture content of the soil.

An Accredited Integrator can help you with specific applications that you may require.

The Grid Fail Generator Backup section controls the Solar Hybrid function allowing for a Backup Generator to be automatically controlled during times of Grid failure. These setting must be used in conjunction with an optional external controller supplied by Selectronic. Full details of correct settings will be supplied with the optional controller.

Digital Control

Digital Control Input
None

Digital Control Output
None

Output State
Follow

Analogue Control

Analogue Control Input
Analogue Input 1

Input Assert Level
[0 - 60 V]
12

Input De-Assert Level
[0 - 60 V]
6

Analogue Control Output
None

Grid Fail Generator Backup

Grid Fail Backup
Disabled

Grid Available Input
None

Backup Select Output
None

L2
None

L3
None

Split
None



To remotely start the generator set **Generator Remote Start Input** to one of the digital inputs to perform this function. There are 2 modes of operation:

- **Momentary Switch:** If this input is pulsed on for less than 2 seconds the SP PRO will see this as a pulse start and start the generator. A subsequent pulse for less than 2 seconds will stop the generator.
- **On / Off Switch:** If the remote switch is turned on and left on for at least 5 seconds, the SP PRO will continue to run the generator until the switch is turned off at which point the SP PRO will stop the generator.

The digital inputs can be used to protect the motor generator. One or more of the digital inputs can be configured to activate actions, warnings and shut down protection. In the **Generator Available Input** setting you can determine whether the generator is available for automatic control. This is particularly useful to prevent the generator from starting during maintenance or refuelling.

The **Generator Low Fuel input** will initiate an alarm when a suitably positioned sensor provides a warning that the fuel level within the fuel tank is low. The **Generator No Fuel input** will either stop the generator or prevent the SP PRO from attempting to start the generator when there is no fuel.

The **Generator Fault input** can detect signals from the generator control system to either stop the generator or prevent the SP PRO from attempting to start the generator when a fault is present in the generator.

In Generator Outputs you can configure the Run and Start outputs to suit the starting requirements of the motor generator. The **Generator Run Output** will provide a start and run signal for a two wire generator controller. The **Generator Start Output** provides a start and stop pulse signal for three wire generator controllers. See Signal Timing under the Generator Controller settings.

The SP PRO can alert you when there is a problem that may prevent the smooth operation of the power system. This is achieved by configuring one of the outputs in the SP PRO to activate an external alarm, visual or audible, to alert you to a problem.

The **Alarm Output** field allows you to choose which output will be activated during an alarm condition.



Please note that the **Alarm Output** is reverse logic and that the output is active when the alarm is off. This allows the Normally Closed (NC) contacts of one of the relay outputs to be used thereby triggering an alarm condition during a complete system shutdown and loss of Battery supply to the SP PRO.

The **Alarm Type** field lets you choose whether you will be advised of Alerts (warnings of potential problems), Shutdowns (events that have caused the inverter to shut down) or both.

Generator Inputs

Generator Remote Start Input
None

Generator Available Input
Digital Control Input 3

Generator Low Fuel Input
None

Generator No Fuel Input
None

Generator Fault Input
Digital Control Input 2

Generator Outputs

Generator Run Output
Relay Output 1

Generator Start Output
Relay Output 2

Alarm Output

Alarm Output
Relay Output 4

Alarm Type
Alert + Shutdown

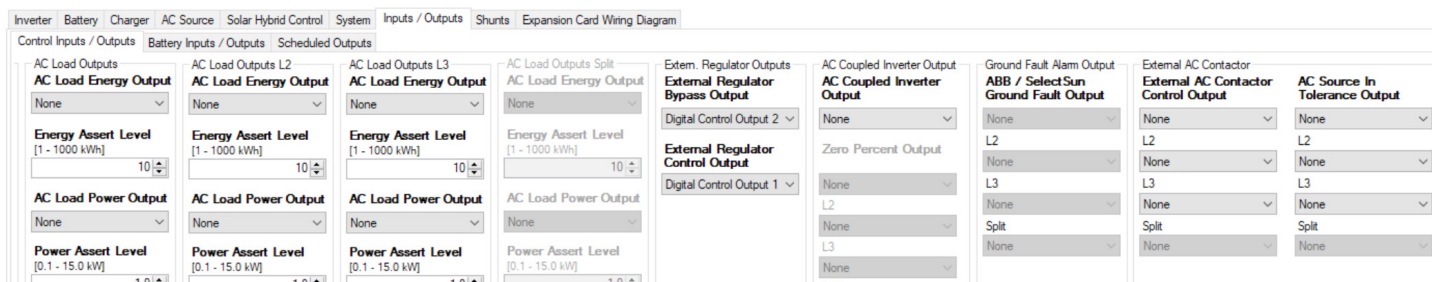

The SP PRO can help you to manage the system by advising you when certain output levels have been exceeded. **AC Load Energy Output** selects the output that will be asserted when the daily energy consumption exceeds **Energy Assert Level** setting.

AC Load Power Output selects the output that will be asserted when the AC load on the system exceeds the **Power Assert Level** for 30 seconds. Conversely the output is de-asserted when the AC load drops below the **power Assert Level** for 30 seconds.

For example let's assume the system has been designed to provide 10 kilowatt hours a day and any load exceeding 5 kilowatts is considered excessive.

In the example on the right, **AC Load Energy Output** has been set to Digital Control Output 1 and this output will be activated when the daily usage reaches 9 kilowatt hours, as programmed into **Energy Assert Level**.

When set in this way the inverter will advise you, but asserting Digital Control Output 1, when you are approaching the design limit of the system and allow you to choose if you wish to modify the power consumption for the remainder of the day. Similarly **AC Load Power Output** has been allocated to Digital Control Output 2 which will be activated if the AC load on the system exceeds the **Power Assert Level** of 4.5 kW for 30 seconds.

External Regulator Bypass Output can be used to control a relay that will bypass the solar or wind generator regulator to allow the full renewable output to be forwarded to the battery or exported to the grid.

The **External Regulator Control Output** provides a signal to drive an external solar regulator

The **AC Coupled Inverter Output** drives an external solid state relay to control when the AC Coupled inverter feeds to the grid, local AC Load and battery bank. This is suitable for switching any Grid feed inverter. This setting is only available for Solar Hybrid (grid connected) configurations.



Any generic AC Coupling is best controlled via AC Frequency. See System settings Generic AC Coupling. The **AC Coupled Inverter Output** is a legacy setting retained for backward compatibility only.

Zero Percent Output setting is configured automatically when the ABB Solar inverter is selected in a Managed AC Coupled Solar configuration. This is for display only and cannot be changed. Only the ABB PVI grid inverter (no longer sold) uses this output. The ABB UNO range of Selectronic Certified grid inverters (current range) do not use this output.

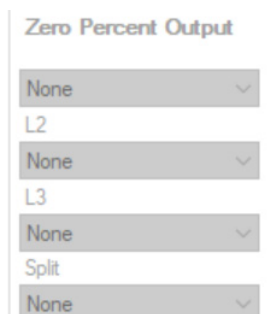
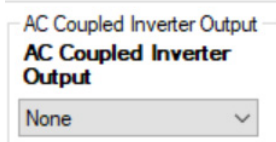
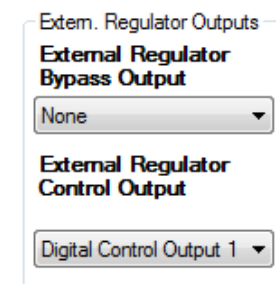
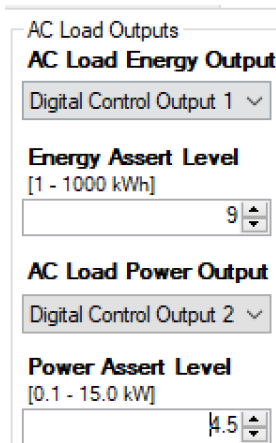



The **ABB / SelectSun Ground Fault Alarm Output** can only be used in a Managed AC coupled system using ABB or SelectSun grid inverters. This output will become active when any of the ABB or SelectSun grid inverters in the system develops a ground fault. This output is set to the last Ground Fault Alarm Message received.

The SP PRO SILENCE ALARM button does not deactivate this output.

Ground Fault Alarm Output
ABB / SelectSun Ground Fault Output

None

L2
None

L3
None

Split
None

If you are using an external contactor **External AC Contactor Control Output** provides a control signal for actuating the contactor coil. See AC Source AC Input to Enable the External Contactor/CT functionality.

This control is also used to provide a grid failure alarm. The output is active during a grid outage.

External AC Contactor
External AC Contactor Control Output

None

L2
None

L3
None

Split
None

AC Source in Tolerance Output configures an output to become active when the AC Source voltage and frequency are in tolerance according to the settings in AC Source / AC Input tab. This output was used in a legacy mutiphase configuration where it is a requirement for all phases to disconnect from the AC Source when one or more phases are out of tolerance. Using this output L2-Secondary and L3-Secondary inverters can signal L1-Primary via the Grid Available Input that they are in tolerance before L1-Primary connects all phases to the AC Source.

This output is a legacy setting that is only used in legacy three phase systems. This setting is not required in a three phase Powerchain system.

AC Source In Tolerance Output

None

L2
None

L3
None

Split
None

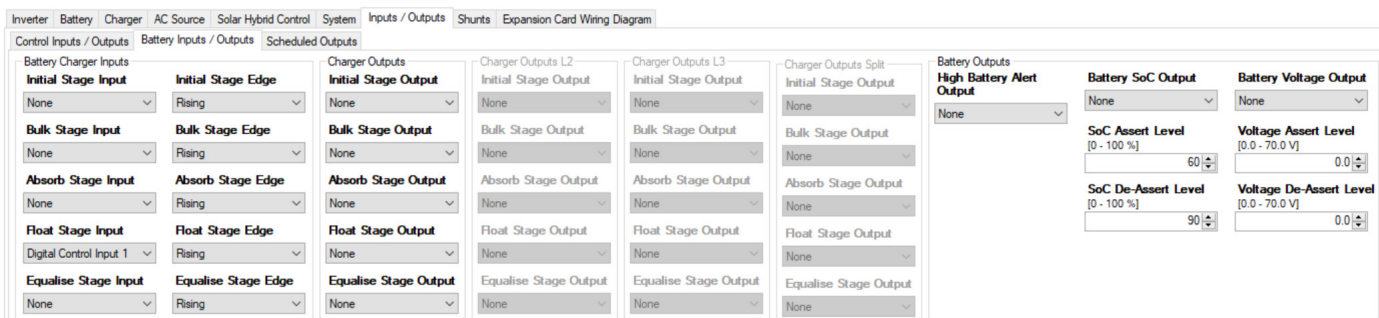

Battery Charger Inputs are used in a variety of ways to help integrate the SP PRO with other renewable chargers. All work in a similar way but just move the charger to a different charging mode.

Care must be taken when using these inputs as improper use can prevent the charger working correctly. Consult an Accredited Integrator for assistance.

The most commonly used would be the Float Stage Input.

Float stage input. Using the drop down menus you can choose which Digital Input you wish to use to control a function. Making this input high or active (> 10 V DC) will force the inverter charge controller into the “Float” stage of the charging process.

Float Stage Edge Consult the regulator manufacturer to determine the output signal the chosen regulator provides. The most common is the default of Rising edge.



SoC will be set to 100% when Float Charging mode is entered.

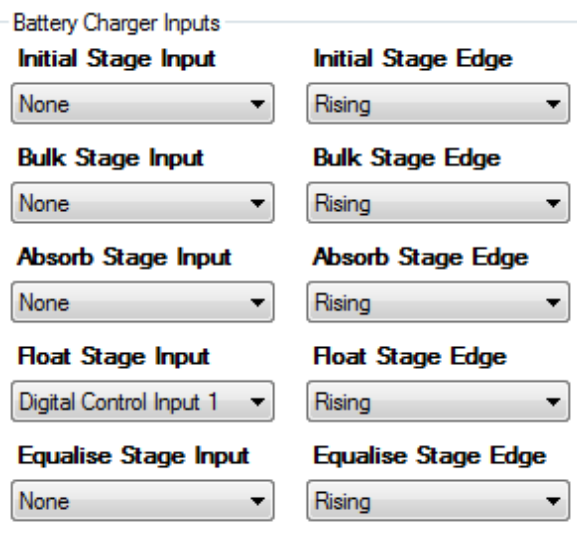

Battery Charger Outputs also help with integration of external chargers but also be used to turn on or off various loads depending on what charge stage the charger is in. All outputs work in the same way, when the charger is in that charging phase, the corresponding output will turn on and subsequently turn off when no longer in that charging phase.

For example, you may wish to only turn on any pumping equipment when the charging process is nearing completion and whilst the charger remains in Float. By selecting the same output “Digital Control Output 3” for both **Absorb Stage Output** and **Float Stage Output** then the output will remain on during both of those charging stages.

High Battery Alert Output is initiated on the chosen output when the battery voltage reaches the Hi Battery Alert set point in the Limits section in the Battery Settings section.

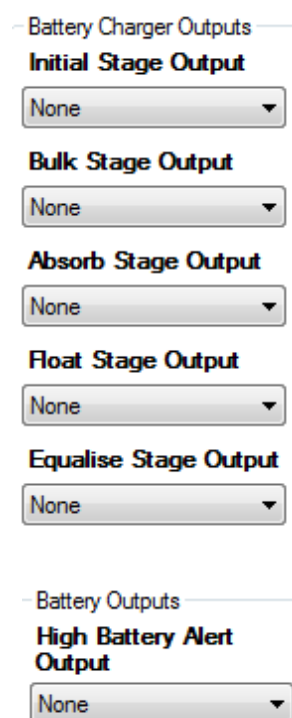



Battery SoC Output initiates the chosen output when the **SoC Assert Level** reaches the programmed SoC Assert Level then switches off the output when the **SoC De-Assert Level** is reached.

If the **SoC Assert Level** is lower than the **SoC De-Assert Level** then the output will become active when the battery SoC drops below the **SoC Assert Level** then deactivate when the battery SoC rises above the **SoC De-Assert Level**.

If the **SoC Assert Level** is higher than the **SoC De-Assert Level** then the output will become active when the battery SoC rises above the **SoC Assert Level** then deactivate when the battery SoC drops below the **SoC De-Assert Level**.

Battery SoC Output

None

SoC Assert Level
[0 - 100 %]
60

SoC De-Assert Level
[0 - 100 %]
90

The **Battery Voltage Output** setting is similar to the prior setting but is based on battery voltage instead of state of charge.

Battery Voltage Output

None

Voltage Assert Level
[0.0 - 70.0 V]
0.0

Voltage De-Assert Level
[0.0 - 70.0 V]
0.0

Inverter Battery Charger AC Source Solar Hybrid Control System Inputs / Outputs Shunts Expansion Card Wiring Diagram

Control Inputs / Outputs Battery Inputs / Outputs Scheduled Outputs

Timed Assert Output

Timed Assert Output	Schedule 1	Schedule 2	Schedule 3	Schedule 4
None	Disabled	Disabled	Disabled	Disabled
Sched. 1 Day	Sched. 2 Day	Sched. 3 Day	Sched. 4 Day	
All	All	All	All	
Sched. 1 Start Time [00:00 - 23:59] 00:00	Sched. 2 Start Time [00:00 - 23:59] 00:00	Sched. 3 Start Time [00:00 - 23:59] 00:00	Sched. 4 Start Time [00:00 - 23:59] 00:00	
Sched. 1 Stop Time [00:00 - 23:59] 00:00	Sched. 2 Stop Time [00:00 - 23:59] 00:00	Sched. 3 Stop Time [00:00 - 23:59] 00:00	Sched. 4 Stop Time [00:00 - 23:59] 00:00	

Timed Assert Output L2

Timed Assert Output	Schedule 1	Schedule 2	Schedule 3
None	Disabled	Disabled	Disabled
Sched. 1 Day	Sched. 2 Day	Sched. 3 Day	
All	All	All	
Sched. 1 Start Time [00:00 - 23:59] 00:00	Sched. 2 Start Time [00:00 - 23:59] 00:00	Sched. 3 Start Time [00:00 - 23:59] 00:00	
Sched. 1 Stop Time [00:00 - 23:59] 00:00	Sched. 2 Stop Time [00:00 - 23:59] 00:00	Sched. 3 Stop Time [00:00 - 23:59] 00:00	

The **Timed Assert Output** schedule similar to the generator run schedule is also provided for a digital output. This facility allows you to control the regular operation of appliances around the home. A typical example would be to turn on a watering system every night for a fixed period.

In a Powerchain Configuration a Timed Assert output can be set for each phase.

Timed Assert Output

Timed Assert Output	Schedule 1	Schedule 2	Schedule 3	Schedule 4
None	Disabled	Disabled	Disabled	Disabled
Sched. 1 Day	Sched. 2 Day	Sched. 3 Day	Sched. 4 Day	
All	All	All	All	
Sched. 1 Start Time [00:00 - 23:59] 00:00	Sched. 2 Start Time [00:00 - 23:59] 00:00	Sched. 3 Start Time [00:00 - 23:59] 00:00	Sched. 4 Start Time [00:00 - 23:59] 00:00	
Sched. 1 Stop Time [00:00 - 23:59] 00:00	Sched. 2 Stop Time [00:00 - 23:59] 00:00	Sched. 3 Stop Time [00:00 - 23:59] 00:00	Sched. 4 Stop Time [00:00 - 23:59] 00:00	

Shunts Settings

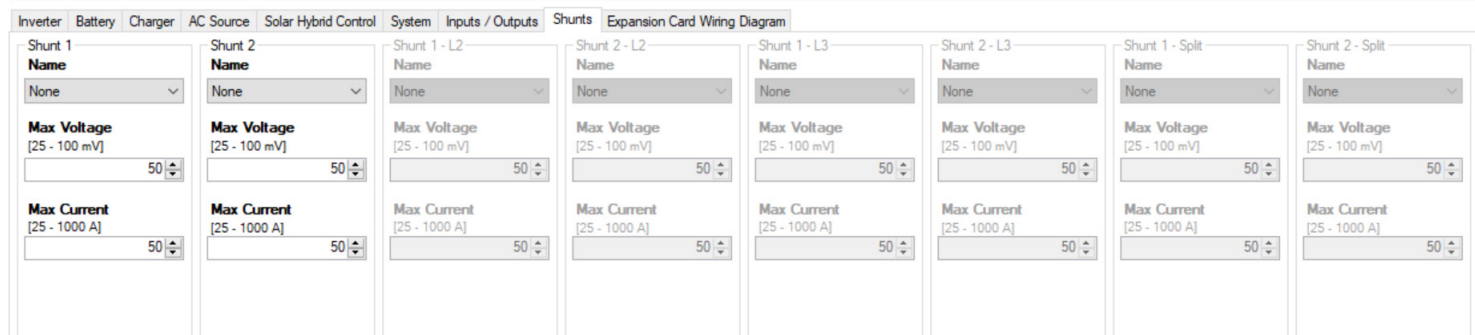

The Shunts tab contains settings required to configure the connected DC current shunts that are used to measure the currents going in or out of the battery bank. The shunt readings are used by the SP PRO to accurately calculate the state of charge of the batteries (System SoC).

A shunt is not required to measure the SP PRO battery current as this is measured internally.



In a Powerchain system the shunts are only allowed in the System Manager (L1 manager).

All shunts are configured for their maximum current and the millivolts at that maximum current. For example for a current shunt rated at 75mV 100A, **Max Voltage** = 75 and **Max current** = 100.

The table below describes the function of each of the Shunt Names

SHUNT TYPE	DESCRIPTION
Solar, Wind, Hydro, Charger	Unidirectional - Measures charging sources. Always assumes charging current so the polarity of the shunt is not critical
Load	Unidirectional - Measure DC loads. Always assumes load current so polarity not critical.
Dual	Bidirectional - Measure DC charging and DC loads. The polarity of the shunt IS critical.
Multiple SP PROs	Bidirectional - Legacy setting that was previously used in Off Grid, multiphase (three phase of split phase) Not used in Powerchain systems.
Log Only	Bidirectional - Used to measure and log a current that is NOT part of the system battery current measurement. This shunt type does to affect the battery current or System SoC.
System SoC	Bidirectional - Legacy Setting used in legacy multi phase (three phase of split phase) Not used in Powerchain systems.
Direct SoC Input (Shunt 1 only)	This setting changes the function of the Shunt 1 input to an analogue input that measures the State of Charge (SoC) from the analogue output of a Battery Management System (BMS). The Voltage for 100% SoC sets the input voltage that generates a 100% SoC within the SP PRO and has a maximum setting of 100mV. If the BMS output is greater than 100mV for 100% SoC then a voltage divider will need to be inserted. When selected, this input overrides the internal SoC calculation.



Expansion Card Wiring Diagram

The Configuration Setting Expansion Card Wiring Diagram shows how you have allocated the input and output functions. It can be used as a guide to placement of control wiring. This diagram is a display of the Configuration Settings on the PC, not the actual settings in the SP PRO.

This guide can be printed for reference during installation and will also include the Site Information.

Expansion card picture may vary depending on SP PRO model. Click Change Card Type to change display to suit the model.

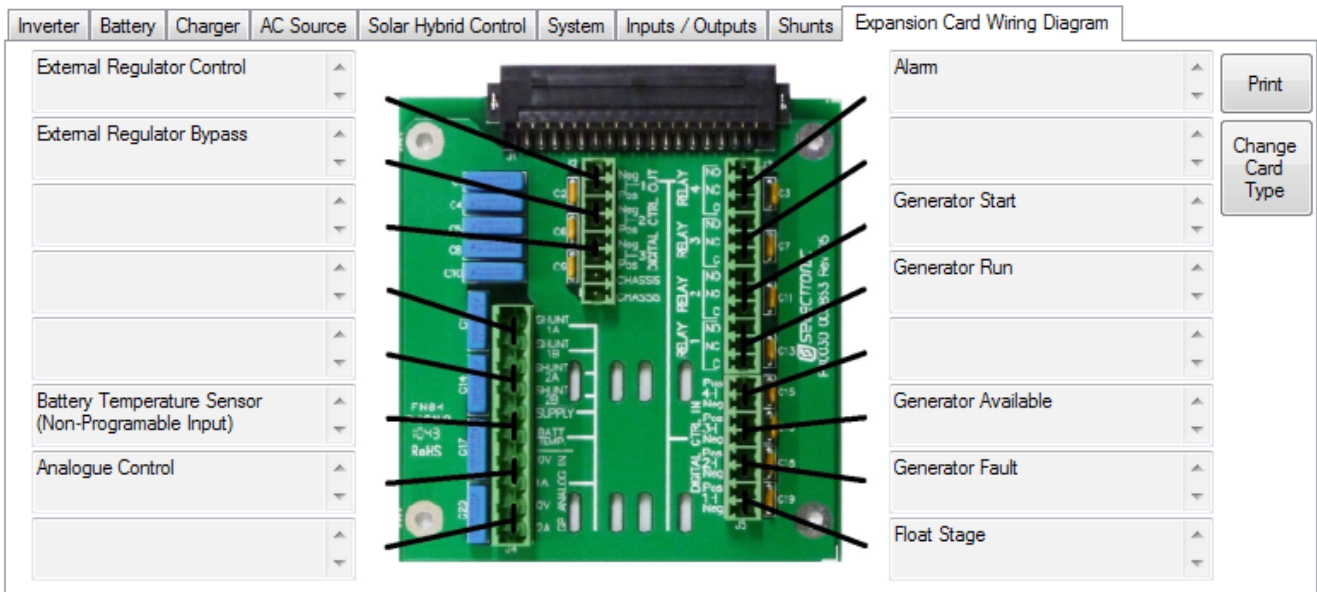

Default configuration shown.

Save and Configure Settings

The configuration settings may now be saved to file or sent to the SP PRO using the "Configure SP PRO" button.

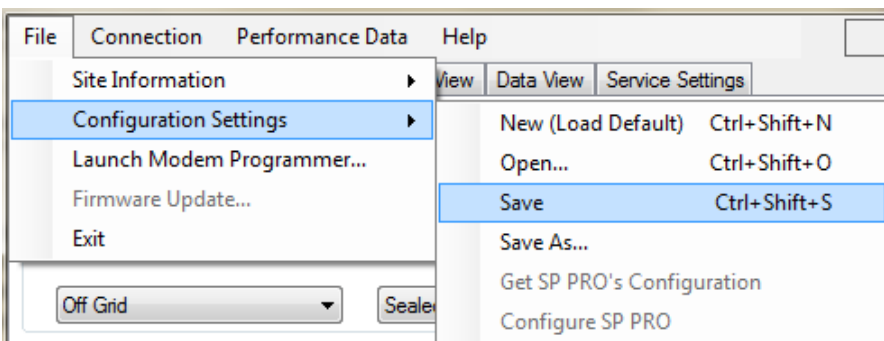

To save the SP PRO configuration settings, click on File - Configuration Settings - Save.

To configure the SP PRO, ensure SP LINK is connected (via connection menu) to the SP PRO and then click "Configure SP PRO" either on the Configuration Screen or in the File - Configuration Settings menu.

Remember that all settings are sent to the SP PRO, not just the ones you have changed. The default passcode is 74. It can be changed in Service Settings.



Performance Monitoring



SP LINK provides a number of options to monitor in real time or review the history of all modes of operation of the power system. These options are -

- Customer Interface
 - Quick View - real time summary of SP PRO system
- Integrator / User Interface
 - Data View - real time detailed information of what is occurring
 - Now,
 - Today and what has occurred
 - Historically
- Integrator / User information
 - Performance Data
 - Historical records for displaying graphically

Customer Interface

The customer interface is called Quick View. Quick View presents you with a screen that mimics the front panel of the SP PRO along with a real time overview of the condition of the system.

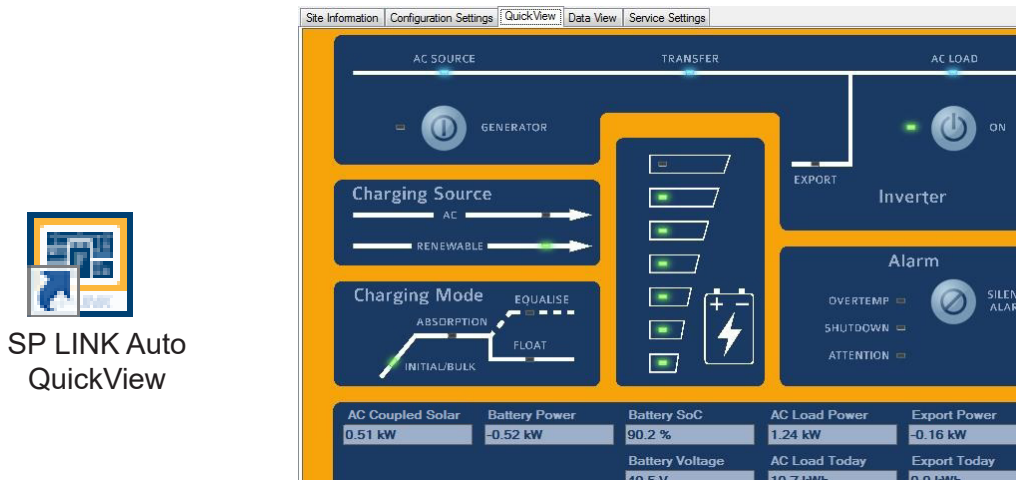

SP LINK Auto QuickView

QuickView can easily be accessed directly from the computers desktop. Click the SP LINK Auto QuickView icon (installed automatically with SP LINK) and the last site will automatically be loaded and a connection (if possible) established.

Integrator / User Interface

The Integrator and User interface is in the Data View tab. Data view contains a number of sections which provide details on the system's operation and the status of the SP PRO.

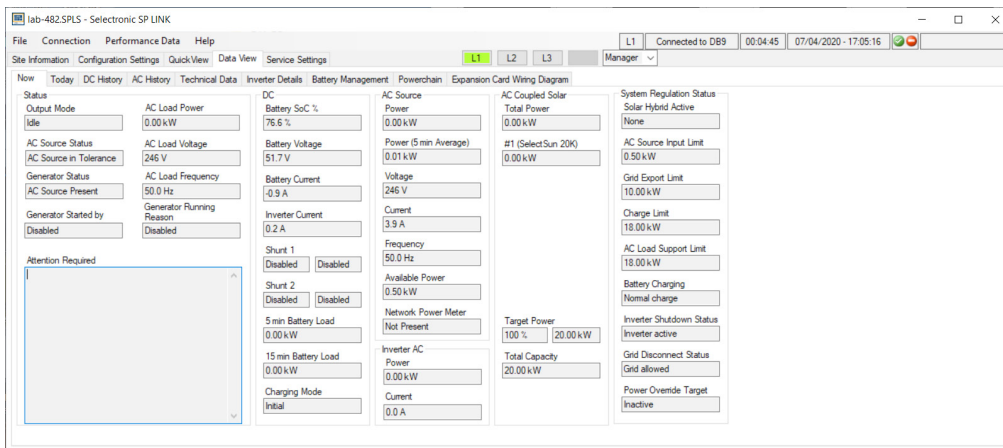

In a Powerchain configuration, buttons appear at the top of the screen labelled L1, L2, L3 and Split along with a Manager / Worker drop down box as applicable. These buttons are used to access the displayed Data View screen for each of the individual inverters. For example, click on L2 and all the screens will display data applicable to the SP PRO on L2 phase manager.

Each section contains details for

- Now - Live values of voltage, current and power plus system status.

- Today - Historical accumulations for the current day

- DC History - A summary of the DC performance of the system over the last 12 months

- AC History - A summary of the AC performance of the system over the last 12 months

- Technical Data - Advanced readings from the inverter.

- Inverter Details - Information about the inverter including serial number and firmware revision.

- Battery Management - Only available with a managed battery system. Information about the battery.

- Powerchain - Only available with Powerchain systems. Summary of each of the phases.

- Expansion Card Wiring

Quick View

Quick View presents you with a screen that mimics the front panel of the SP PRO along with a real time overview of the condition of the system.

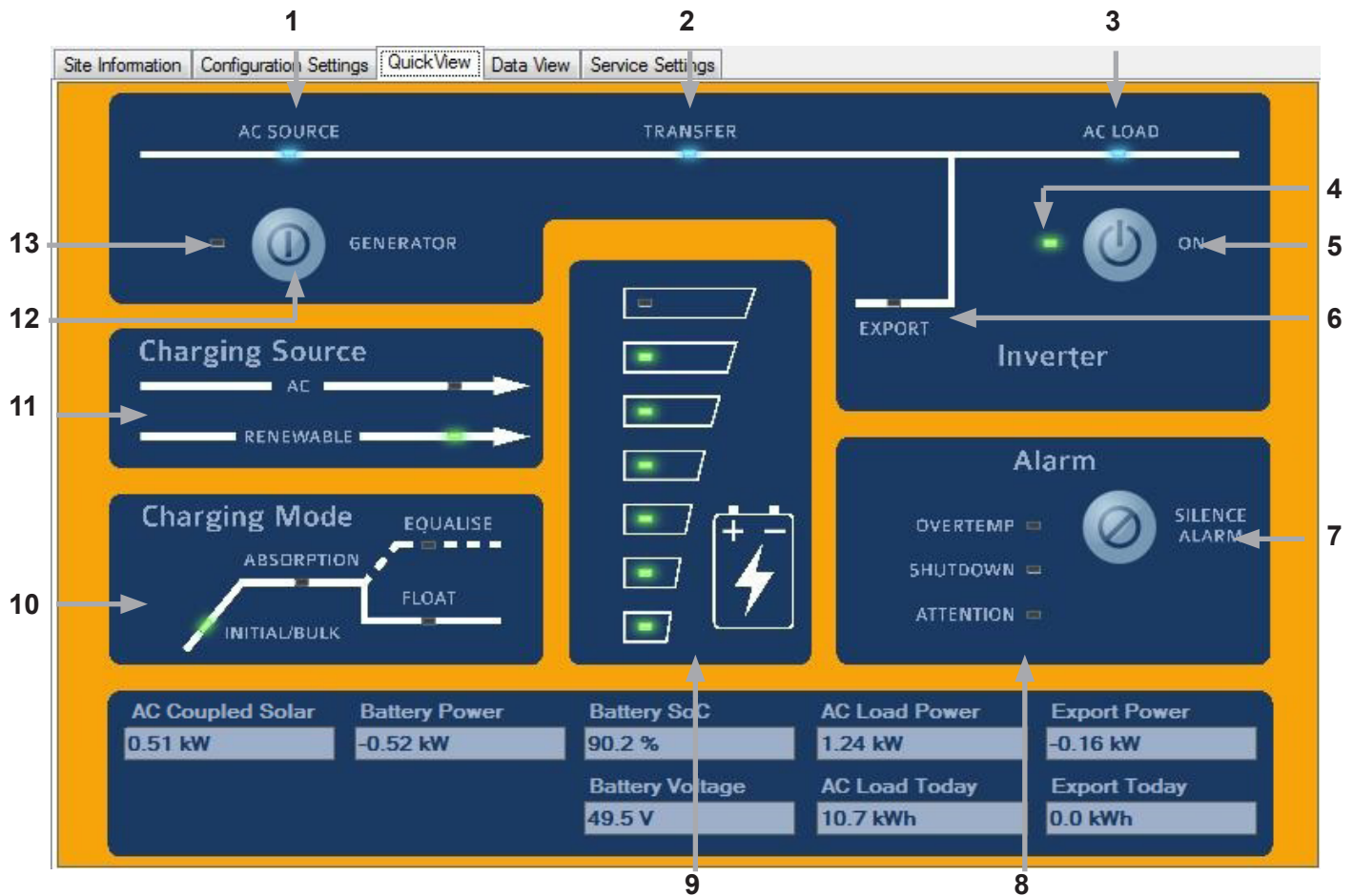

The following page lists the SP PRO control and indicators which correspond to the labelled image above.

The overview shown is for a Solar Hybrid (On Grid) system. The real time overview values shows how much power is being produced (AC Solar) and exported (Export Power and Export Today) as well as the present consumption (AC Load Power and AC Load Today). The battery condition (Battery SoC and Battery Voltage) is also indicated.

The overview for a Off Grid system varies slightly such that the Export Power and Export Today are replaced by the Generator Status and Gen Started.

AC Coupled Solar	Battery Power	Battery SoC	AC Load Power	Generator Status
2.12 kW	2.06 kW	98.4 %	0.38 kW	Not Running
Solar (Shunt 1)	Load (Shunt 2)	Battery Voltage	AC Load Today	Gen Started
1.01 kW	0.65 kW	57.1 V	3.4 kWh	Not Running

DC shunts are enabled in this example and their real time values are shown as Solar (Shunt 1) and Load (Shunt 2).



1 AC SOURCE *

When illuminated shows the presence of AC supply voltage from either a generator or the grid, whichever is applicable. This is powered directly from the incoming AC supply.

2 TRANSFER *

Illuminated when an external AC supply is connected through to the AC LOAD output. If AC SOURCE is illuminated but not TRANSFER, it would indicate that either the AC supply's voltage or frequency are beyond the set limits or the active Priority Schedule is set to "Grid Disconnected". If the AC supply is a motor generator, check if it needs servicing; if the mains grid, check with your supplier for a problem, or for either, that the set limits are suitable. It is normal operation for this to flicker slightly.

3 AC LOAD *

When illuminated, this shows the presence of AC voltage ready to supply loads. This is powered directly from the inverter AC output or AC supply.



The above indicators (1,2 & 3) will operate without any DC connection to the inverter. An external AC supply will activate the AC bypass and illuminate these indicators.

4 OUTPUT MODE STATUS

- Off** Inverter is disconnected from Battery supply. AC bypass only.
- Slow Flashing Yellow** Inverter is Idle (Off) - Monitoring and logging but no inverter AC output.
- Steady Green** Inverter is On.
- Slow Flashing Green** Econo mode is active and sensing
- Fast Flashing Green** Inverter is preparing to start.
- Steady Red** Indicates that a Fault has been detected and inverter is shutdown.
- Flashing Red** Indicates an open circuit or poor battery connection or inverter not configured. Inverter is shutdown.

5 ON BUTTON

A LONG PRESS (>1 sec) - turns the Inverter On. Another long press reverts to Idle.
Two long button presses will start **AC Coupled Low DC recovery** - See next page for details.

6 EXPORT

In grid connected systems, indicates that the SP PRO is feeding renewable power: to the load or the grid.
On, renewables exporting to the grid and supplying Loads;
Flashing, renewables supplying Loads only.
NOTE: The EXPORT indicator may flicker occasionally at night when no renewable are available. This is normal operation and is due to transients in the load power or grid voltage.

7 SILENCE ALARM BUTTON

The Silence Alarm button cancels any audible alarm. This does not remove the alarm, just the audible component. This button is not active when SP PRO is in Idle.

8 ALARM INDICATORS

OVERTEMP

- Yellow** SP PRO is approaching an over temperature condition
- Red** SP PRO has shutdown due to an over temperature condition

SHUTDOWN

- Yellow:** SP PRO is approaching a shutdown condition
- Red** SP PRO has shutdown

ATTENTION

- Off** Normal
- Yellow** Attention Required, Fan Service Request
- Flashing Yellow** Clean Fan, Fan Fault or Capacitor Service
- Red** Immediate Attention required
- Flashing RED** Unit Fault

See Attention Required in SP LINK Data View - Now section to determine specific reason for the attention indicator.

9 BATTERY "FUEL" GAUGE

These represent either the battery voltage or State of Charge (SoC). By default, battery voltage is indicated. All indicators on green indicate Float or higher voltage. If just the bottom indicator is on red, battery voltage is approaching the SP PRO Shutdown voltage.

If the SP PRO has SoC Control enabled, these will represent the percentage of usable charge remaining in the batteries. Usable charge is defined from 100% SoC down to the Shutdown SoC parameter.

Top Indicator

- Flashing RED:** Instant Hi DC Voltage Shutdown

Bottom Indicator

- Yellow** Low Battery
- Red** Low Battery Shutdown
- Flashing RED** Instant Low DC Voltage Shutdown

When all are flashing RED, inverter is in Low DC Shutdown Override. In emergency situations, this override enables the SP PRO to be forced to work beyond the battery shutdown limits. The SP PRO will continue to operate at reduced capacity until the battery can no longer supply enough to keep the inverter and loads running. We remind you, this emergency feature may damage the batteries or connected equipment.

10 CHARGING MODE

The Charging Mode panel indicates the present charging mode being performed by either connected Charging Source, or the stage that will be started when Renewable or external AC supply becomes available. **Note:** SoC will be set to 100% when Float Charging Mode is entered.

11 CHARGING SOURCE

- AC - On External AC supply charging battery bank
- Renewable - On Monitored renewable supply is charging battery bank

DC Coupled renewable supplies must be monitored via an external current shunt(s) to activate this indicator.

12 GENERATOR START/STOP BUTTON

A brief press of this button (<1 second) will start or stop the generator.
Two Long presses - Set or cancel Equalise Charge pending (see [Click here for Request Battery Equalise on page 87.](#))

13 GENERATOR STATUS

- Off** No generator activity
- Flashing Green** Generator is in the process of starting
- Steady Green** Generator has started and is running
- Flashing Yellow** Generator is not available for auto start
- Flashing Red** Generator failed to start or in fault.

AC Coupled Low DC Recovery

This feature is only available in systems that have AC coupled solar installed. It uses the AC coupled solar to recover from a Low DC voltage or Low SoC shutdown.

This feature is used when the AC Source (Generator or Grid supply) is not available, possibly due to a failed generator or long term grid outage.

To use the **AC Coupled Low DC Recovery** feature follow these simple steps.

1. Wait until the sun is up and there is enough sunlight to charge the batteries.
2. Turn off all the loads connected to the SP PRO. If this is not done then the **AC Coupled Low DC Recovery** mode will exit within 5 seconds.
3. Long Press ON button Twice. The SP PRO will go into **AC Coupled Low DC Recovery** mode and come on to power up the AC coupled grid inverters. The battery LEDs on the front of the SP PRO will flash red when in this mode. If the AC coupled solar does not start charging the batteries within 10 minutes then the SP PRO will exit this mode.

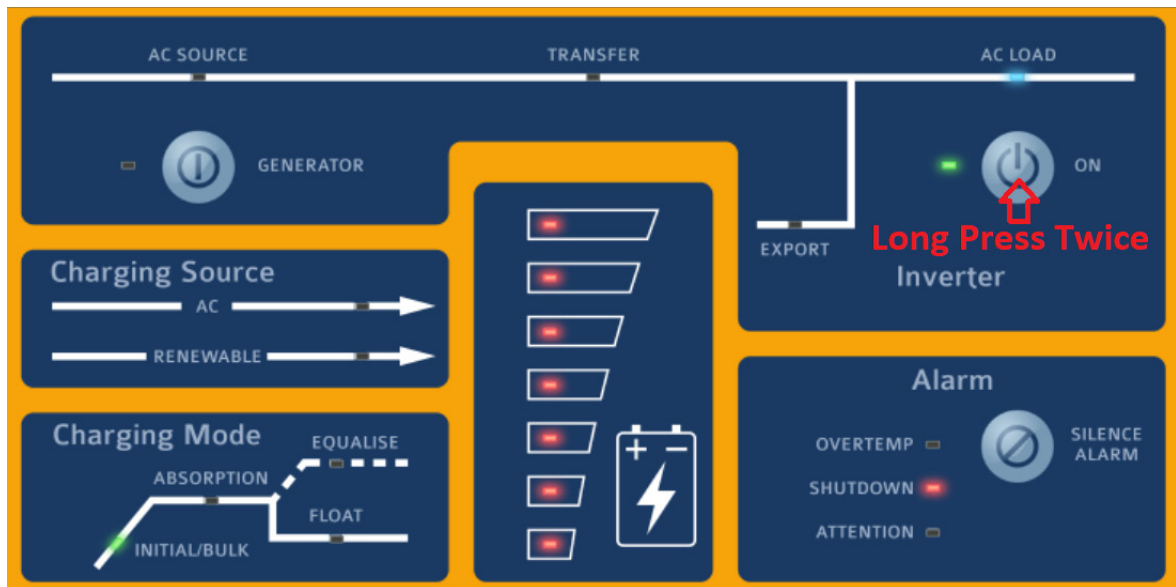

4. Wait until Low DC shutdown recovers. When the battery LEDs stop flashing red and the SP PRO remains on then the system has recovered.

5. Turn on your loads. The battery has now recovered enough to run the loads. Minimise power usage to avoid another shutdown.



Data View

If you require more detailed data about the system clicking on Data View opens a screen containing comprehensive data about the SP PRO and the system

Now Tab

The Now tab gives you live information about what is happening to the system now.

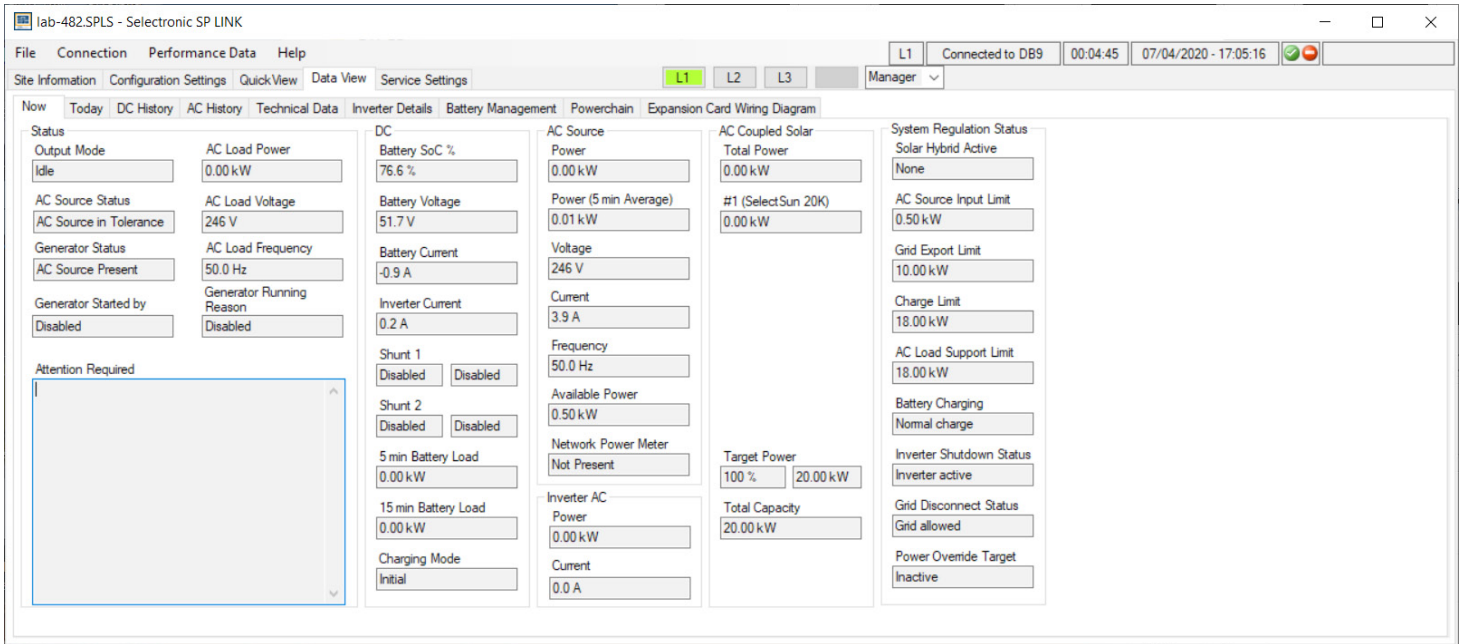

STATUS

OUTPUT MODE: The mode in which the SP PRO is running, such as Idle, On or Synchronised

GENERATOR STATUS – Available, Not Available or AC Present.

GENERATOR STARTED BY: The reason the generator has started such as high load.

GENERATOR RUNNING REASON: The reason it is still running If you feel that the generator has been running too long this is the area to check.

AC LOAD POWER: The power being taken by the loads in kW. When Generic AC coupled Solar is installed this reading becomes the load power less any generic AC coupled solar power.

AC LOAD VOLTAGE: The AC voltage being delivered to the load

AC LOAD FREQUENCY: The frequency of the AC voltage being delivered to the load.

If the Attention indicator is flashing on the front panel, check the **Attention Required** area to find out the cause.

For further information see “Appendix One Alert Messages” on page 98 .The table in this section outlines all the SP PRO ALERT type event messages, the most likely cause and possible remedies.

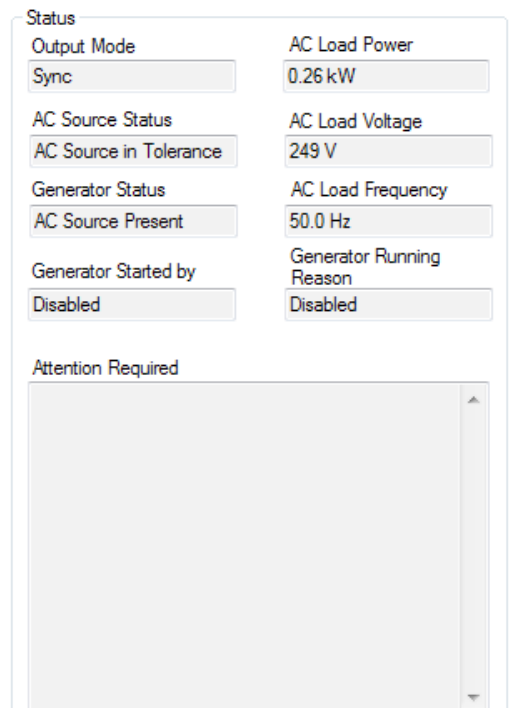

[See Appendix One Alert Messages on page 98](#)

DC

This screen gives you vital information about the state of the batteries at the time of viewing. The BATT SoC% indicates the actual capacity left in the batteries, just like a fuel gauge in your car, and will help you make decisions about the power consumption for the rest of the day. Similarly the Battery Voltage gives a rough guide to battery condition.

The next four readings give you an overview of what's going into and coming out of the batteries. Inverter Current shows the amperage being used by the SP PRO to run AC loads or the amperage being contributed to battery charging if the generator is running.

DC BATTERY CURRENT is the nett amount going into or out of the battery pack. If the Solar Current is greater than the loads a positive figure will be shown while if the loads are greater than the combination of charging sources a negative figure will appear. Load Current is the measurement of DC loads monitored by the Load shunt.

CHARGING MODE indicates the active stage - Initial, Bulk, Absorb, Float (Short or Long Term) or Equalise Charging.



SoC will be set to 100% when Float Charging Mode is entered.

DC	
Batt SoC %	100.0 %
Battery Voltage	58.2 V
Battery Current	1.4 A
Inverter Current	1.6 A
Solar (Shunt 1)	14.6 A 0.85 kW
Load (Shunt 2)	11.6 A 0.67 kW
5 min Battery Load	0.00 kW
15 min Battery Load	0.00 kW
Charging Mode	Short Term Float

AC SOURCE

This section displays the contribution and condition of the mains grid or motor generator that is connected to the SP PRO AC Source input.

- POWER reading is the input power in kilowatts.
- POWER (5MIN AVERAGE) is the average power in kW over the last 5 minutes.
- VOLTAGE is the RMS AC voltage.
- CURRENT is in Amps.

AVAILABLE POWER is the difference between the POWER reading and the AC SOURCE POWER setting in the SP PRO. The SP PRO will automatically reduce the charge power to the batteries or draw power from the batteries as required to keep the AC Source power below the AC SOURCE POWER Setting.

NETWORK POWER METER displays the total power as measured by an externally connected three phase power meter. Contact Selectronic or visit the web site for more information.

AC Source	
Power	0.07 kW
Power (5 min Average)	0.29 kW
Voltage	250 V
Current	0.4 A
Frequency	50.0 Hz
Available Power	49.93 kW
Network Power Meter	Not Present

INVERTER AC

This panel is similar to the preceding panel except that it shows the Inverter Power and Current from the inverter.

Inverter AC	
Power	-0.14 kW
Current	-0.8 A

AC COUPLED SOLAR

The panel shows the total Power and individual output powers from each of the connected compatible grid Inverters. These are listed as Power #1 through to Power #5 along with the grid inverter's model number (when connected). If the SP PRO has lost communications with the grid inverter or the grid inverter has gone to "sleep" at night, the message "Inverter Offline" is displayed.

PERCENTAGE POWER is the maximum output of all the connected compatible grid inverters as a percentage of the TOTAL CAPACITY. As an example if the TOTAL CAPACITY is 10kW and the PERCENTAGE POWER IS 50% then the maximum output from all the connected grid inverters is 5kW.



The PERCENTAGE POWER may be displaying less than 100% even though no power limiting is required. This is because the SP PRO intelligently uses predictive algorithms to determine the optimum value based on the available solar input to the grid inverter at that time

AC Coupled Solar	
Total Power	1.50 kW
Power #1 (PVI-3.6)	1.50 kW
Percent Power	100 %
Total Capacity	3.60 kW

TOTAL CAPACITY is the total rated power of all the connected grid inverters. This reading will drop to zero when the grid inverters go to "sleep" at night.



SYSTEM REGULATION STATUS

This panel shows the control status and power limits active within the SP PRO mainly for the Solar Hybrid Control configurations. These power limit values also hold true for Off Grid and Mobile. These values are the configured maximums defined by the Solar Hybrid Control however the system may not be capable of achieving these values and can be overruled.

SOLAR HYBRID ACTIVE: Shows the active Priority Schedule (1 - 8), Alternate or None.

- PRIORITY 1 TO PRIORITY 8: Indicates the currently active Priority Schedule.
- NONE: indicates that no Priority Schedules are active at this time.
- ALTERNATE indicates the Alternate AC Input is active and all Priority Schedules are overridden.

The items listed below are the configuration values and limits for the SOLAR HYBRID ACTIVE

AC SOURCE INPUT LIMIT: The maximum AC Source (Grid or Generator) input power allowed for AC Load or Battery Charging at this time. This limit will be breached if the AC Load demands more power than this limit and AC LOAD SUPPORT LIMIT combined.

GRID EXPORT LIMIT: The maximum Grid export power allowed at this time. This limit will always be 0,00kW when the Unit Application is set to Off Grid or Mobile.

CHARGE LIMIT: The maximum Battery Charge power allowed at this time. The Charge Power will be capped at this value regardless of the charge power required by the SP PRO Charger (See Configuration Settings > Charger). The CHARGE LIMIT will display the maximum charge limit of the SP PRO when either:

- No Priority Schedules are active
- The Restricted Charge Limit setting in the active Priority Schedule is greater than the maximum charge limit of the SP PRO

AC LOAD SUPPORT LIMIT: The maximum AC Load power that can be taken from the battery bank. This limit will be breached if the SP PRO is not synchronised to the AC Source input.

BATTERY CHARGING: Shows the status of the SP PRO Battery Charging function:

- RESTRICTED CHARGE, The Charge power is restricted to the CHARGE LIMIT within a Priority Schedule
- CHARGER OFF. The Charge is off and wont charge the battery. The AC LOAD SUPPORT LIMIT is still active
- RENEWABLE ONLY Allows battery recharging from both AC Coupled or DC coupled renewable sources but not from the AC Source (Grid) supply.
- NORMAL CHARGE. This is displayed when no Priority Schedules are active.

INVERTER DISCONNECT STATUS: Shows if the inverter within the SP PRO is active or disconnected.

- INVERTER ACTIVE: all the normal charging and support functions operate.
- INVERTER DISCONNECTED: There is no AC Battery Charging (AC Coupled or Grid), AC Load Support, AC Source Input Limit or any Support or Export from DC coupled solar. If the Grid is interrupted, the Inverter switches on after a short break in supply (< 1.0 seconds) to provide back-up power.

GRID DISCONNECT STATUS: Shows if the Grid is allowed or is being kept disconnected

- GRID ALLOWED: The SP PRO will synchronise to the grid when available.
- GRID DISCONNECTED: The SP PRO will not synchronise to the grid even though the grid maybe within voltage and frequency tolerance.

If INVERTER DISCONNECTED is active during GRID DISCONNECTED, the GRID DISCONNECTED will be overridden.

POWER OVERRIDE TARGET: No function within standard SP PRO units. Contact Selectronic for details.

Recovering Message: When the battery State of Charge (SoC) reaches the **SoC Support Limit** within the active Priority Schedule the highlighted message “Recovery” appears within the affected reading. When the SoC recovers by 20% of the discharge (eg from 60% to 68%) the displayed readings return back to normal.

System Regulation Status
Solar Hybrid Active
Priority 8

AC Source Input Limit
50.00 kW

Grid Export Limit
5.00 kW

Charge Limit
5.80 kW

AC Load Support Limit
6.00 kW

Battery Charging
Charger Off

Inverter Disconnect Status
Inverter active

Grid Disconnect Status
Grid allowed

Power Override Target
0.00 kW

System Regulation Status
Solar Hybrid Active
Priority 5

AC Source Input Limit
0.00 kW Recovering

Grid Export Limit
0.20 kW

Charge Limit
6.47 kW

AC Load Support Limit
-0.01 kW Recovering

Battery Charging
Charger Off

Inverter Disconnect Status
Inverter active

Grid Disconnect Status
Grid allowed

Power Override Target
0.00 kW Recovering

Today Tab

The TODAY tab gives you data about the system for the current day.

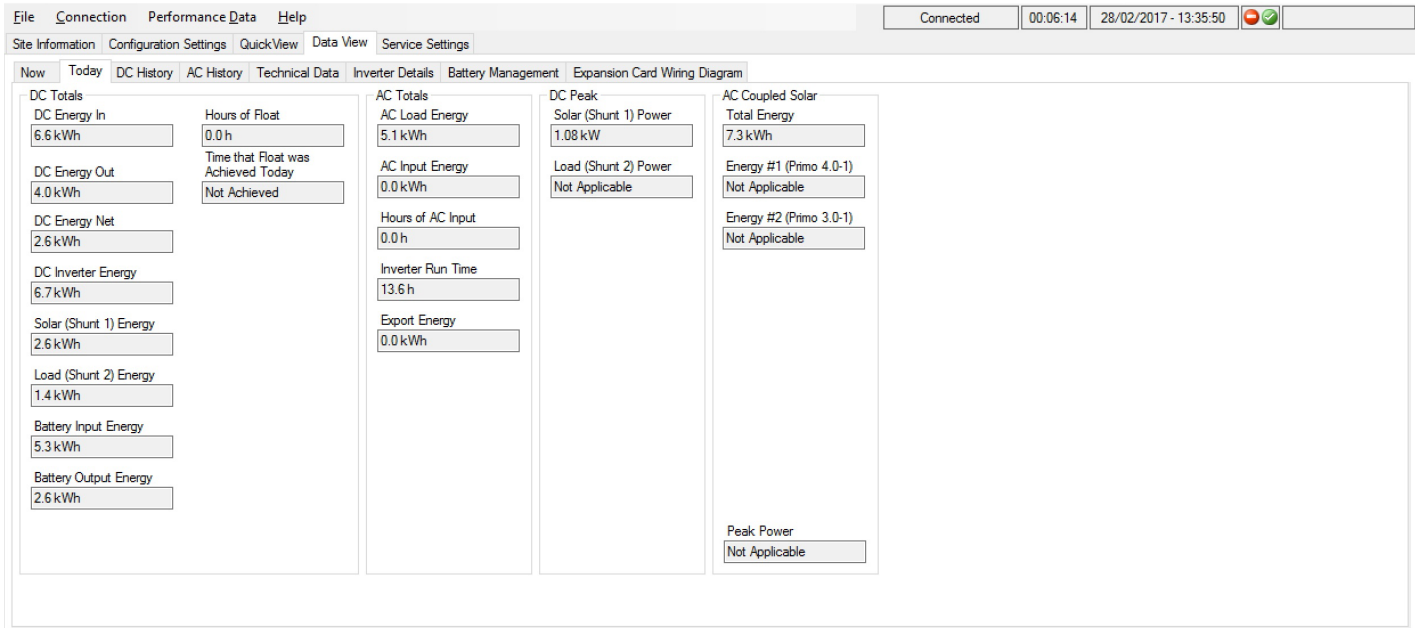

The screenshot shows the 'Today' tab in the SP LINK Performance Monitoring software. The interface includes a menu bar (File, Connection, Performance Data, Help) and a status bar (Connected, 00:06:14, 28/02/2017 - 13:35:50). Below the menu bar are tabs for Site Information, Configuration Settings, QuickView, Data View, and Service Settings. The main content area is divided into several panels:

- DC Totals:** DC Energy In (6.6 kWh), DC Energy Out (4.0 kWh), DC Energy Net (2.6 kWh), DC Inverter Energy (6.7 kWh), Solar (Shunt 1) Energy (2.6 kWh), Load (Shunt 2) Energy (1.4 kWh), Battery Input Energy (5.3 kWh), Battery Output Energy (2.6 kWh).
- Hours of Float:** 0.0 h, Time that Float was Achieved Today (Not Achieved).
- AC Totals:** AC Load Energy (5.1 kWh), AC Input Energy (0.0 kWh), Hours of AC Input (0.0 h), Inverter Run Time (13.6 h), Export Energy (0.0 kWh).
- DC Peak:** Solar (Shunt 1) Power (1.08 kW), Load (Shunt 2) Power (Not Applicable).
- AC Coupled Solar:** Total Energy (7.3 kWh), Energy #1 (Primo 4.0-1) (Not Applicable), Energy #2 (Primo 3.0-1) (Not Applicable), Peak Power (Not Applicable).

DC TOTALS

This panel is a summary of today's totals of inputs and outputs through the battery pack. DC ENERGY IN is compared to DC ENERGY OUT to arrive at DC ENERGY NET and the results are recorded in kW hours. DC Inverter Energy is a total of the work the inverter has done, whether that is supplying a load or charging. If you wish to monitor the day to day performance of the system Time That Float Was Achieved Today can be compared with yesterdays in the DC HISTORY tab. This can be a handy comparative reading. You can record daily how long it takes the system to replenish the previous days usage.

AC TOTALS

This is also a summary page, but this time of the AC kW hours through the system. AC LOAD ENERGY records the total power consumption by the site during that day. AC INPUT ENERGY shows the total contribution by the generator or the mains grid, while HOURS OF AC INPUT records the running time of the generator or the length of time the mains grid was connected to the SP PRO. INVERTER RUN TIME is the length of time the inverter has run today – this should be all the time unless you have programmed in an Inverter Lockout period. In grid connected systems EXPORT ENERGY is the total power the system has contributed to the mains grid in that day.

DC PEAK

This screen records the peak power level that has passed through the shunt(s) that day. Not Applicable means the shunt isn't configured for measuring renewable.

AC COUPLED SOLAR

AC Energy (kWh) generated by the Managed AC coupled grid inverters. The Individual energy readings (Energy #1 etc) are not available when ABB grid inverters are used in a managed AC coupled system.

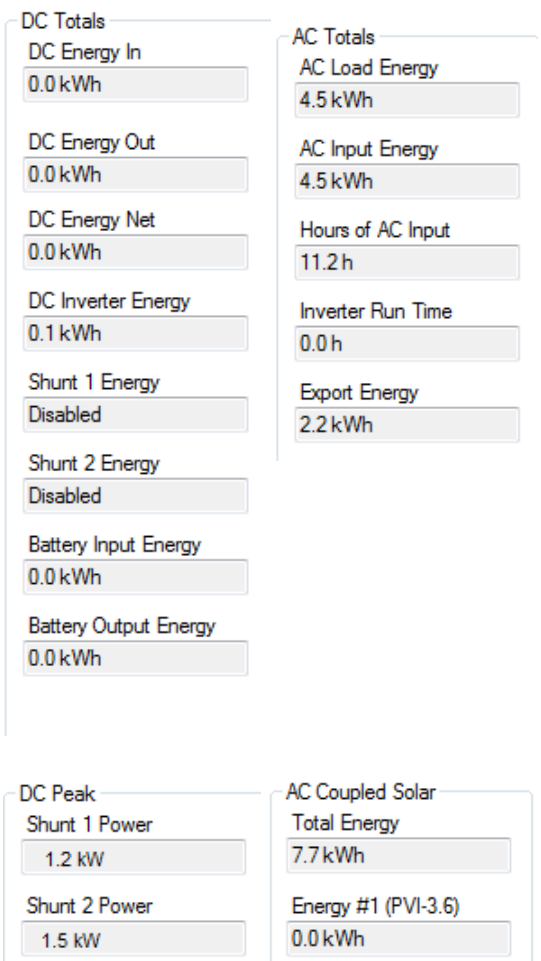

The summary panels provide a quick overview of the system's performance:

- DC Totals:** DC Energy In (0.0 kWh), DC Energy Out (0.0 kWh), DC Energy Net (0.0 kWh), DC Inverter Energy (0.1 kWh), Shunt 1 Energy (Disabled), Shunt 2 Energy (Disabled), Battery Input Energy (0.0 kWh), Battery Output Energy (0.0 kWh).
- AC Totals:** AC Load Energy (4.5 kWh), AC Input Energy (4.5 kWh), Hours of AC Input (11.2 h), Inverter Run Time (0.0 h), Export Energy (2.2 kWh).
- DC Peak:** Shunt 1 Power (1.2 kW), Shunt 2 Power (1.5 kW).
- AC Coupled Solar:** Total Energy (7.7 kWh), Energy #1 (PVI-3.6) (0.0 kWh).



DC History Tab

The next tab is the DC HISTORY screen. As the name implies this screen gives you data from the previous day, the last seven days, the last 30 days, the last year and the whole period since installation.

Battery Input Energy	Battery Output Energy
Previous Day's Total 2.0 kWh	Previous Day's Total 2.5 kWh
7 Day Total 22.8 kWh	7 Day Total 16.3 kWh
7 Day Daily Average 3.22 kWh	7 Day Daily Average 2.32 kWh
30 Day Total 97 kWh	30 Day Total 76 kWh
30 Day Daily Average 3.22 kWh	30 Day Daily Average 2.54 kWh
365 Day Total 432 kWh	365 Day Total 342 kWh
365 Day Daily Average 1.12 kWh	365 Day Daily Average 0.90 kWh
Year to Date Total 30 kWh	Year to Date Total 22 kWh
Daily Average 3.29 kWh	Daily Average 2.39 kWh
Year Starting on 01/01 [dd/mm]	Year Starting on 01/01 [dd/mm]
Resettable Total 910 kWh	Resettable Total 507 kWh
Daily Average 0.75 kWh	Daily Average 0.37 kWh
Reset on 00/00/00 [dd/mm/yyyy] <input type="button" value="Reset"/>	Reset on 00/00/00 [dd/mm/yyyy] <input type="button" value="Reset"/>
Total Accumulated 910 kWh	Total Accumulated 507 kWh

All the input to the battery bank

All the output.

DC ENERGY RESETTABLE is like a trip meter in your car. When reset this records DC energy in and out of the system and gives a net total.

RESET ON: shows the date when last reset so you can calculate how many days have elapsed. By clicking the Reset tab all totals in this reading are zeroed and accumulation of data starts again on the date of the reset.

DC Energy Resettable

Total In
910.1 kWh

Total Out
506.8 kWh

Total Net
403.1 kWh

Reset On **00/00/00**
[dd/mm/yyyy]

HOURS OF FLOAT records what time float was achieved on the previous day and how much time has been spent in float since installation.

This data can be used for future system improvement design. If the system never reaches float, you may need to increase the solar array size, if the system regularly enters float before lunch you may be able to consider adding extra “luxury” loads to the system.



SoC will be set to 100% when Float Charging Mode is entered.

Hours of Float

Previous Day's Total 9.3 h	Previous Day Float Achieved at Disabled
7 Day Total 93.6 h	7 Day Daily Average 13.4 h
30 Day Total 248.3 h	30 Day Daily Average 8.3 h
365 Day Total 6170.6 h	365 Day Daily Average 17.0 h

Year to Date

Total 117.5 h	Daily Average 13.1 h
------------------	-------------------------

Year Starting on **01/01** [dd/mm]

This panel gives a picture of the effect that Shunt 1 has had on the system. For the sake of clarity we will assume that Shunt 1 measures the solar input. This, then, records the solar contribution to the system since the system was installed. Once again you can compare today's solar input with other averages to see if you've had a good or a bad solar day.

As with the previous screen you can collect data over a period you determine with the use of the RESETTABLE feature.

The TOTAL ACCUMULATED is all the solar input to the system since installation.

Solar (Shunt 1) Energy

Previous Day's Total 0.0 kWh	Previous Day's Peak Power 0.00 kW
7 Day Total 0.0 kWh	7 Day Daily Average 0.0 kWh
30 Day Total 0 kWh	30 Day Daily Average 0.00 kWh
365 Day Total 0 kWh	365 Day Daily Average 0.00 kWh

Year to Date

Total 0 kWh	Daily Average 0.00 kWh
----------------	---------------------------

Year Starting on **01/01** [dd/mm]

Resettable

Total 0 kWh	Daily Average 0.00 kWh
----------------	---------------------------

Reset on **00/00/00**
[dd/mm/yyyy]

Total Accumulated
0 kWh



This panel is the historical record of the Shunt 2 and its effect on the system, either through a renewable contribution, if it is measuring input through a wind turbine or micro hydro, or as a deduction through DC loads. In the case shown, DC Loads.

Load (Shunt 2) Energy

Previous Day's Total	Previous Day's Peak Power
0.0 kWh	Not applicable
7 Day Total	7 Day Daily Average
0.0 kWh	0.0 kWh
30 Day Total	30 Day Daily Average
0 kWh	0.00 kWh
365 Day Total	365 Day Daily Average
0 kWh	0.00 kWh

Year to Date

Total	Daily Average
0 kWh	0.00 kWh

Year Starting on **01/01** [dd/mm]

Resetable

Total	Daily Average
0 kWh	0.00 kWh

Reset on **00/00/00**
[dd/mm/yyyy]

Total Accumulated

0 kWh

This panel shows historical data of all of the DC energy that has passed into or out of the inverter.

This panel also gives you the ability to accumulate this data from a date you determine. By pressing the Reset tab all totals in this reading are zeroed and accumulation of data starts again on the date of the reset.

A particular feature of this panel is the ability to compare the previous days total with the averages over a week, a month or a year.

DC Inverter Energy

Previous Day's Total	
4.6 kWh	
7 Day Total	7 Day Daily Average
39.2 kWh	5.53 kWh
30 Day Total	30 Day Daily Average
174 kWh	5.76 kWh
365 Day Total	365 Day Daily Average
774 kWh	2.09 kWh

Year to Date

Total	Daily Average
51 kWh	5.68 kWh

Year Starting on **01/01** [dd/mm]

Resetable

Total	Daily Average
1417.0 kWh	1.20 kWh

Reset on **00/00/00**
[dd/mm/yyyy]

Total Accumulated

1417 kWh

AC History Tab

The AC HISTORY SCREEN, as with the DC History screen gives you data from the previous day, the last seven days, the last 30 days, the last year and the whole period since installation

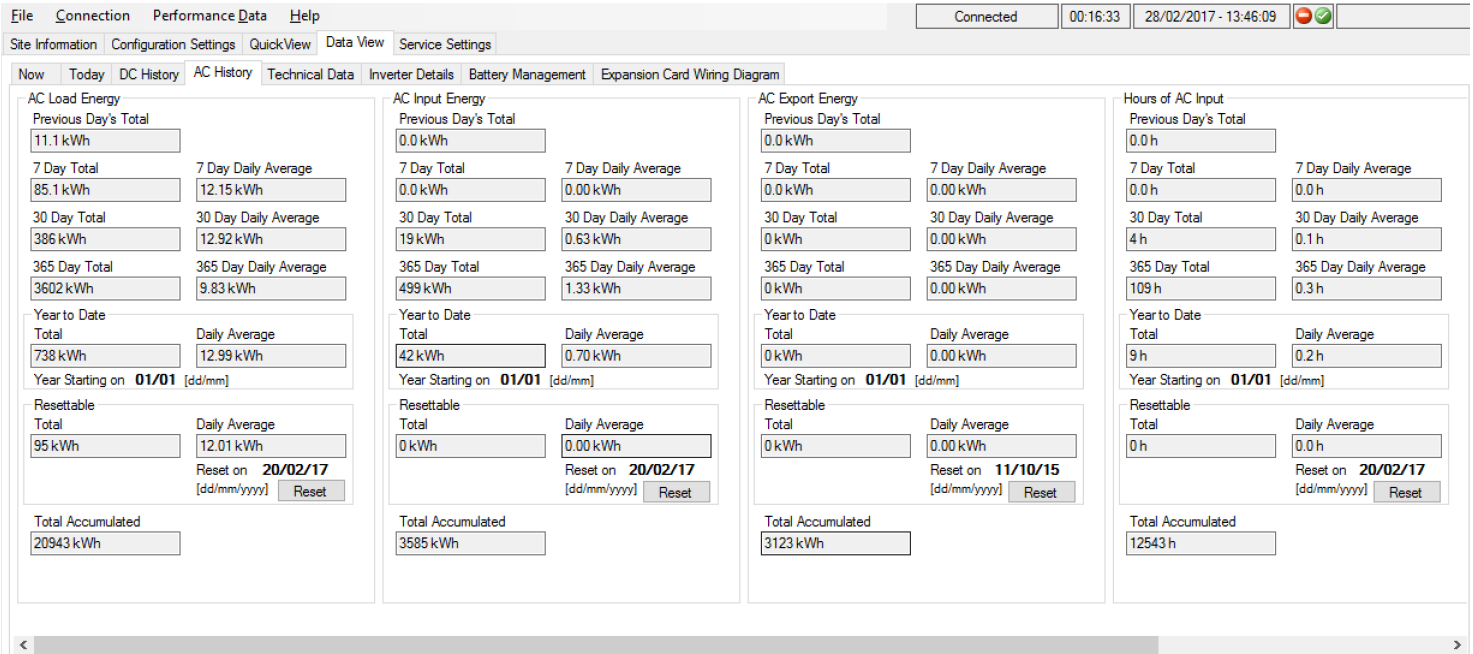

AC Load Energy	AC Input Energy	AC Export Energy	Hours of AC Input
Previous Day's Total: 11.1 kWh	Previous Day's Total: 0.0 kWh	Previous Day's Total: 0.0 kWh	Previous Day's Total: 0.0 h
7 Day Total: 85.1 kWh	7 Day Total: 0.0 kWh	7 Day Total: 0.0 kWh	7 Day Total: 0.0 h
7 Day Daily Average: 12.15 kWh	7 Day Daily Average: 0.00 kWh	7 Day Daily Average: 0.00 kWh	7 Day Daily Average: 0.0 h
30 Day Total: 386 kWh	30 Day Total: 19 kWh	30 Day Total: 0 kWh	30 Day Total: 4 h
30 Day Daily Average: 12.92 kWh	30 Day Daily Average: 0.63 kWh	30 Day Daily Average: 0.00 kWh	30 Day Daily Average: 0.1 h
365 Day Total: 3602 kWh	365 Day Total: 499 kWh	365 Day Total: 0 kWh	365 Day Total: 109 h
365 Day Daily Average: 9.83 kWh	365 Day Daily Average: 1.33 kWh	365 Day Daily Average: 0.00 kWh	365 Day Daily Average: 0.3 h
Year to Date Total: 738 kWh	Year to Date Total: 42 kWh	Year to Date Total: 0 kWh	Year to Date Total: 9 h
Daily Average: 12.99 kWh	Daily Average: 0.70 kWh	Daily Average: 0.00 kWh	Daily Average: 0.2 h
Year Starting on: 01/01	Year Starting on: 01/01	Year Starting on: 01/01	Year Starting on: 01/01
Resettable Total: 95 kWh	Resettable Total: 0 kWh	Resettable Total: 0 kWh	Resettable Total: 0 h
Daily Average: 12.01 kWh	Daily Average: 0.00 kWh	Daily Average: 0.00 kWh	Daily Average: 0.0 h
Reset on: 20/02/17	Reset on: 20/02/17	Reset on: 11/10/15	Reset on: 20/02/17
Total Accumulated: 20943 kWh	Total Accumulated: 3585 kWh	Total Accumulated: 3123 kWh	Total Accumulated: 12543 h

This is a record of the total AC loads presented by the home to the power system.

This is the total AC input contributed by the motor generator or by the mains grid.

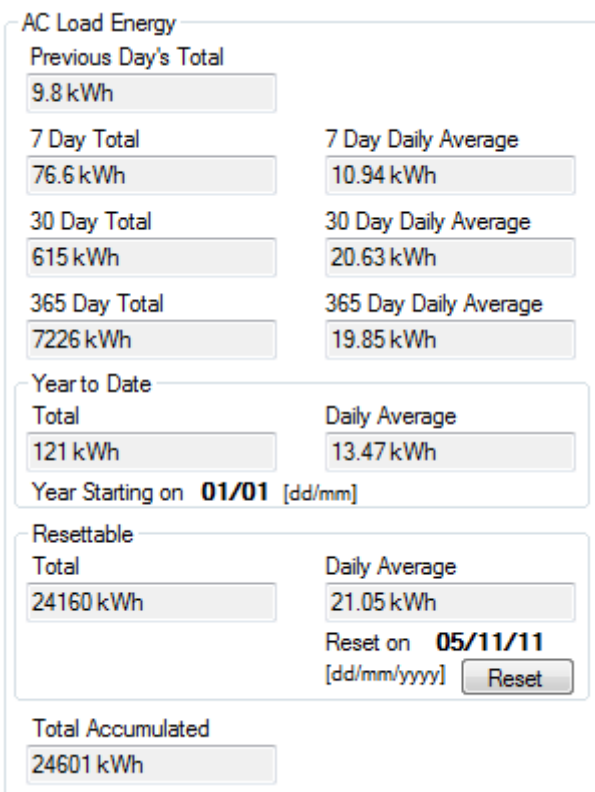

AC Load Energy

Previous Day's Total: 9.8 kWh

7 Day Total: 76.6 kWh

7 Day Daily Average: 10.94 kWh

30 Day Total: 615 kWh

30 Day Daily Average: 20.63 kWh

365 Day Total: 7226 kWh

365 Day Daily Average: 19.85 kWh

Year to Date Total: 121 kWh

Daily Average: 13.47 kWh

Year Starting on: 01/01

Resettable Total: 24160 kWh

Daily Average: 21.05 kWh

Reset on: 05/11/11

Total Accumulated: 24601 kWh

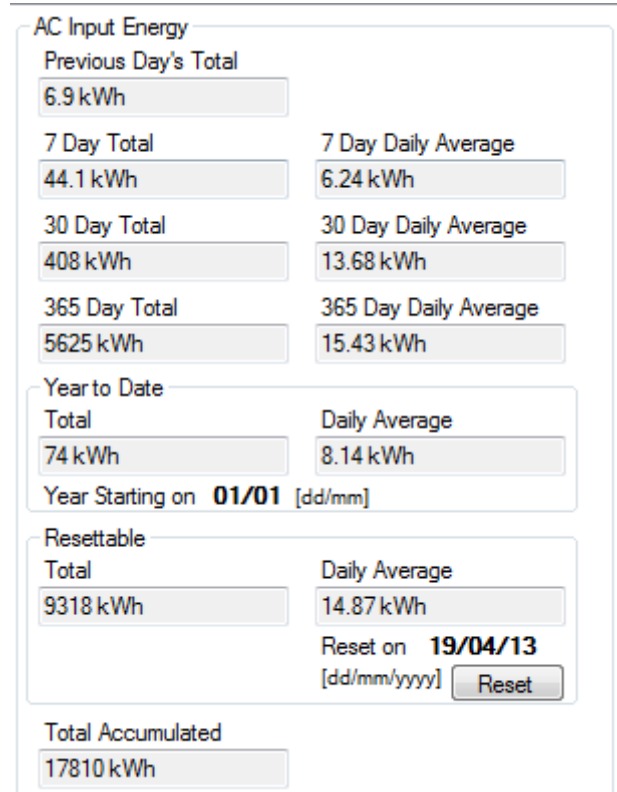

AC Input Energy

Previous Day's Total: 6.9 kWh

7 Day Total: 44.1 kWh

7 Day Daily Average: 6.24 kWh

30 Day Total: 408 kWh

30 Day Daily Average: 13.68 kWh

365 Day Total: 5625 kWh

365 Day Daily Average: 15.43 kWh

Year to Date Total: 74 kWh

Daily Average: 8.14 kWh

Year Starting on: 01/01

Resettable Total: 9318 kWh

Daily Average: 14.87 kWh

Reset on: 19/04/13

Total Accumulated: 17810 kWh



In grid connected systems you can monitor the amount of energy exported to the grid comparing today's total with the last week, month or year.

A record of how many hours the generator has run or for how long the mains grid was connected.

AC Export Energy

Previous Day's Total
3.4 kWh

7 Day Total: 102.0 kWh | 7 Day Daily Average: 14.59 kWh

30 Day Total: 521 kWh | 30 Day Daily Average: 17.47 kWh

365 Day Total: 3574 kWh | 365 Day Daily Average: 9.82 kWh

Year to Date
Total: 132 kWh | Daily Average: 14.73 kWh
Year Starting on **01/01** [dd/mm]

Resettable
Total: 11035 kWh | Daily Average: 9.61 kWh
Reset on **05/11/11** [dd/mm/yyyy]

Total Accumulated
11037 kWh

Hours of AC Input

Previous Day's Total
23.9 h

7 Day Total: 167.4 h | 7 Day Daily Average: 24.0 h

30 Day Total: 714 h | 30 Day Daily Average: 24.0 h

365 Day Total: 8703 h | 365 Day Daily Average: 24.0 h

Year to Date
Total: 215 h | Daily Average: 24.0 h
Year Starting on **01/01** [dd/mm]

Resettable
Total: 27472 h | Daily Average: 24.0 h
Reset on **05/11/11** [dd/mm/yyyy]

Total Accumulated
27481 h

Total AC Coupled Solar Energy input to the system.

AC Coupled Solar Energy

Previous Day's Total
5.6 kWh

7 Day Total: 139.8 kWh | 7 Day Daily Average: 19.99 kWh

30 Day Total: 750 kWh | 30 Day Daily Average: 25.12 kWh

365 Day Total: 5218 kWh | 365 Day Daily Average: 14.31 kWh

Year to Date
Total: 187 kWh | Daily Average: 20.84 kWh
Year Starting on **01/01** [dd/mm]

Resettable
Total: 15821 kWh | Daily Average: 14.94 kWh
Reset on **02/02/12** [dd/mm/yyyy]

Total Accumulated
15821 kWh

Technical Data Tab

The TECHNICAL DATA tab provides you with information relating to maintenance and updating the SP PRO.

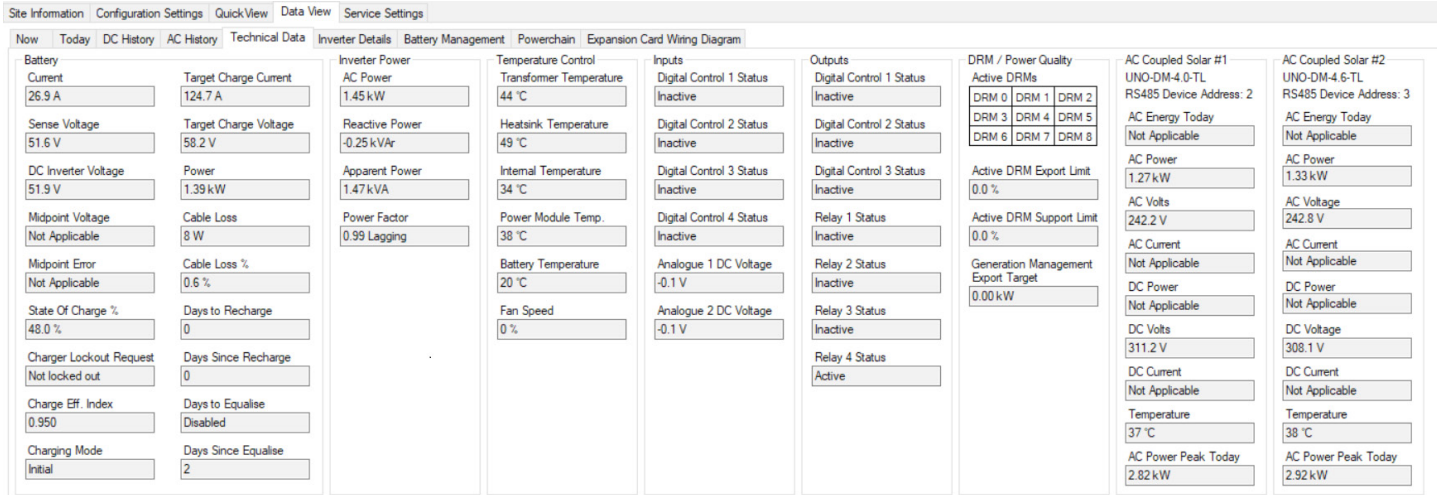

The screenshot shows the 'Technical Data' tab in the SP PRO interface. It is divided into several columns of data:

- Battery:** Current (26.9 A), Target Charge Current (124.7 A), Sense Voltage (51.6 V), Target Charge Voltage (58.2 V), DC Inverter Voltage (51.9 V), Power (1.39 kW), Midpoint Voltage (Not Applicable), Cable Loss (8 W), Midpoint Error (Not Applicable), Cable Loss % (0.6%), State Of Charge % (48.0%), Days to Recharge (0), Charger Lockout Request (Not locked out), Days Since Recharge (0), Charge Eff. Index (0.950), Days to Equalise (Disabled), Charging Mode (Initial), Days Since Equalise (2).
- Inverter Power:** AC Power (1.45 kW), Reactive Power (-0.25 kVA), Apparent Power (1.47 kVA), Power Factor (0.99 Lagging).
- Temperature Control:** Transformer Temperature (44 °C), Heatsink Temperature (49 °C), Internal Temperature (34 °C), Power Module Temp. (38 °C), Battery Temperature (20 °C), Fan Speed (0 %).
- Inputs:** Digital Control 1 Status (Inactive), Digital Control 2 Status (Inactive), Digital Control 3 Status (Inactive), Digital Control 4 Status (Inactive), Analogue 1 DC Voltage (-0.1 V), Analogue 2 DC Voltage (-0.1 V).
- Outputs:** Digital Control 1 Status (Inactive), Digital Control 2 Status (Inactive), Digital Control 3 Status (Inactive), Relay 1 Status (Inactive), Relay 2 Status (Inactive), Relay 3 Status (Inactive), Relay 4 Status (Active).
- DRM / Power Quality:** Active DRMs (DRM 0-8), Active DRM Export Limit (0.0 %), Active DRM Support Limit (0.0 %), Generation Management Export Target (0.00 kW).
- AC Coupled Solar #1:** UNO-DM-4.0-TL, RS485 Device Address: 2, AC Energy Today (Not Applicable), AC Power (1.27 kW), AC Volts (242.2 V), AC Current (Not Applicable), DC Power (Not Applicable), DC Volts (311.2 V), DC Current (Not Applicable), Temperature (37 °C), AC Power Peak Today (2.82 kW).
- AC Coupled Solar #2:** UNO-DM-4.6-TL, RS485 Device Address: 3, AC Energy Today (Not Applicable), AC Power (1.33 kW), AC Voltage (242.8 V), AC Current (Not Applicable), DC Power (Not Applicable), DC Voltage (308.1 V), DC Current (Not Applicable), Temperature (38 °C), AC Power Peak Today (2.92 kW).

CURRENT is a measurement of the current in the battery bank. A positive (+) value, the battery is charging. A negative (-) value, the battery is discharging.

SENSE VOLTAGE is a measurement of the battery voltage at the battery terminals (When using a managed battery or when the battery sense/pre-charge wiring is installed)

TARGET CHARGE CURRENT and **TARGET CHARGE VOLTS** Show the present temperature compensated charge current and voltage of the SP PRO battery charger.

DC INVERTER VOLTAGE is a measurement of the battery voltage within the SP PRO

POWER is the amount of power presently drawn from the battery bank and is used in conjunction with Cable Loss to determine its significance.

MIDPOINT VOLTAGE is a measurement of half the battery voltage at the battery terminals (when the battery sense/pre-charge wiring is installed) If this value is not half the Sense Voltage then the batteries need equalising or there is a faulty cell.

MIDPOINT ERROR is a measurement of the error in the midpoint voltage as a %.

CABLE LOSS is the amount of power that is dissipated in the battery cabling, fusing and terminal system. A high reading could indicate a problem with the battery terminals, battery connection to the SP PRO or inadequate cable sizing.

CABLE LOSS % is the Cable loss as a percentage of the Battery power at that time.

SoC % is the State of Charge of the battery bank. 100% SoC is a full battery.

DAYS TO RECHARGE and **DAYS SINCE RECHARGE** - If Periodic Recharge is enabled these readings track the days since the last battery recharge and how many days before the next battery recharge.

CHARGER LOCKOUT REQUESTED indicates when the charger is off and there is no charging from the SP PRO.

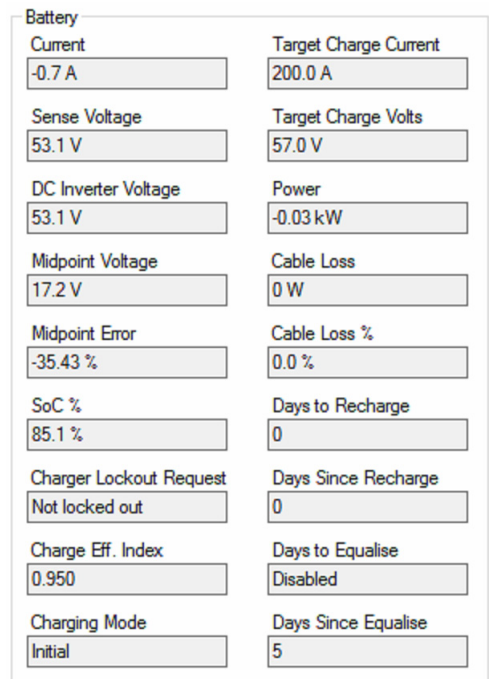



CHARGE EFFICIENCY INDEX is an internally adjusted factor that is used to constantly calibrate the State of Charge calculation within the SP PRO. It also gives an indication of the battery health with a value below 0.8 suggesting that the batteries may need replacing. A normal value is between 0.9 and 1.0

DAYS TO EQUALISE and DAYS SINCE EQUALISE record how long since the batteries received an equalising charge and how long before one is due. When an external charging source raises the battery voltage to the Equalise voltage for the Equalise period the SP PRO will see this as a completed Equalise Charge.

CHARGING MODE shows the stage of battery charger in the SP PRO. This is the same information as shown on the front panel of the SP PRO.

AC POWER is a measurement of the real power being passed through the inverter between the DC sources (Battery bank and DC coupled charging sources) and its AC output. A positive (+) value, the inverter is charging the battery. A negative (-) value, the inverter is supporting the load from the DC sources.

Inverter Power

AC Power
-0.76 kW

Reactive Power
0.00 kVAr

Apparent Power
0.76 kVA

Power Factor
1.00

REACTIVE POWER is a measure of the VARs being provided by the SP PRO.

APPARENT POWER is a measure of the inverter's AC voltage x AC current (volt amps).

POWER FACTOR is that of the inverter AC output. This is not a measure of the power factor of the load except when the SP PRO is in stand alone (not synchronised to the grid or a generator) and with no AC coupled solar input.

The TEMPERATURE CONTROL panel displays the temperatures of various components within the SP PRO under the present operating conditions. This will assist support personnel to determine the cause of thermally related system issues.

Temperature Control

Transformer Temperature
38 °C

Heatsink Temperature
43 °C

Internal Temperature
36 °C

Power Module Temp.
37 °C

Battery Temperature
24 °C

Fan Speed
0 %

The INPUTS AND OUTPUTS panel monitors the status of the digital and analogue inputs and outputs. Active is ON and Inactive is OFF.

Inputs	Outputs
Digital Control 1 Status Active	Digital Control 1 Status Active
Digital Control 2 Status Inactive	Digital Control 2 Status Inactive
Digital Control 3 Status Inactive	Digital Control 3 Status Inactive
Digital Control 4 Status Inactive	Relay 1 Status Inactive
Analogue 1 DC Voltage 0.4 V	Relay 2 Status Inactive
Analogue 2 DC Voltage 0.4 V	Relay 3 Status Inactive
	Relay 4 Status Active

When DRM is enabled then the currently asserted DRM is highlighted in the Active DRM display.

ACTIVE DRM EXPORT LIMIT shows, in percent the limit placed by the currently asserted DRM on the Export Power of the SP PRO. Only DRM 5 to DRM 8 effect the ACTIVE DRM EXPORT LIMIT.

ACTIVE DRM SUPPORT LIMIT shows, in percent the limit placed by the currently asserted DRM on the amount of power that the SP PRO can use from the grid to charge the battery bank. Only DRM 1 to DRM 4 effect the ACTIVE DRM SUPPORT LIMIT.

GENERATION MANAGEMENT EXPORT TARGET shows, in percent the amount of export power that the SP PRO must generate to remain within the ramp rate limits of the **Generation Management Mode**.

DRM / Power Quality		
Active DRMs		
DRM 0	DRM 1	DRM 2
DRM 3	DRM 4	DRM 5
DRM 6	DRM 7	DRM 8
Active DRM Export Limit		
<input type="text"/>		
Active DRM Support Limit		
<input type="text"/>		
Generation Management Export Target		
<input type="text"/>		

The AC Solar panels (#1 through to #5 when connected) display all of the data fed back from each Managed AC coupled grid connect unit.

The “RS485 Device Address” shows the Address that has been configured in that particular grid inverter. For KACO or Fronius inverters this is address 1 to 5 for AC Solar #1 to AC Solar #5 respectively. For ABB inverters the RS485 Device address is 2 to 6 respectively.

When ABB solar grid inverters are connected to the SP PRO, there are 4 readings that are not available from the ABB solar grid inverter. AC Energy today, AC current, DC power and DC current.

When Fronius solar grid inverters are connected to the SP PRO, there are 7 readings that are not available from the Fronius solar grid inverter. AC Energy today, AC Volts, AC current, DC power, DC Volts, DC current and Temperature.

If the SP PRO has lost communications with a grid inverter or the grid inverter has gone to “sleep” at night, the message “Inverter Offline” is displayed in all its readings except AC Power Peak Today

AC Solar #1 (Primo 4.0-1) RS485 Device Address: 1	AC Solar #2 (Primo 3.0-1) RS485 Device Address: 2
AC Energy Today Not Applicable	AC Energy Today Not Applicable
AC Power 0.72 kW	AC Power 0.54 kW
AC Volts Not Applicable	AC Volts Not Applicable
AC Current Not Applicable	AC Current Not Applicable
DC Power Not Applicable	DC Power Not Applicable
DC Volts Not Applicable	DC Volts Not Applicable
DC Current Not Applicable	DC Current Not Applicable
Temperature Not Applicable	Temperature Not Applicable
AC Power Peak Today 1.50 kW	AC Power Peak Today 1.36 kW



Inverter Details Tab

The INVERTER DETAILS tab provides you with information about the SP PRO.

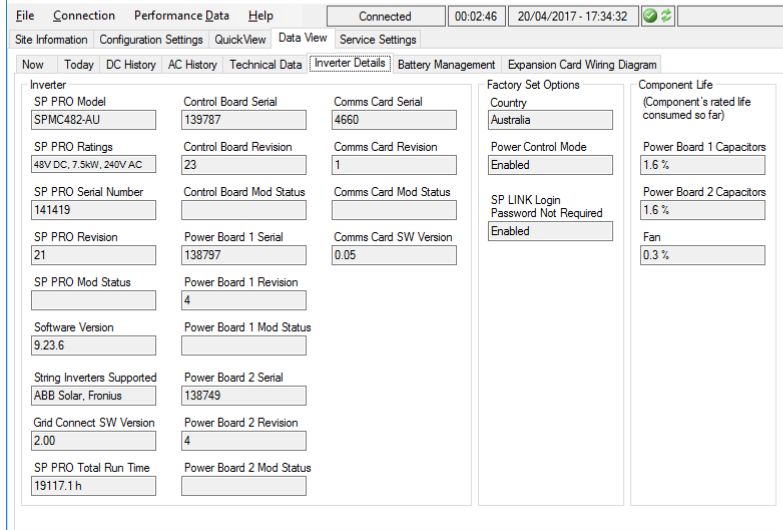

In the INVERTER section we show you the SOFTWARE VERSION and hardware that is currently installed in the inverter. From time to time, as Selectronic designs new features for the SP PRO, new revisions of software may become available from our web site. Generally, there is no need to update the SP PRO unless you need the new features made available.

TOTAL RUN TIME tells you the total number of hours the inverter has run.

If the SP PRO is fitted with a Comms Card 2027 then the card's serial number, hardware revision and firmware revision is recorded under COMMS PCA SERIAL. Otherwise this section is greyed out.

FACTORY SET OPTIONS displays the configurations that have been set in the factory. These settings cannot be changed.

The SP PRO monitors the life-span of certain components within the inverter. By advising you of the amount of CAPACITOR LIFE and FAN LIFE that have been consumed SP LINK allows you to plan for long term maintenance at a time that will not inconvenience you.

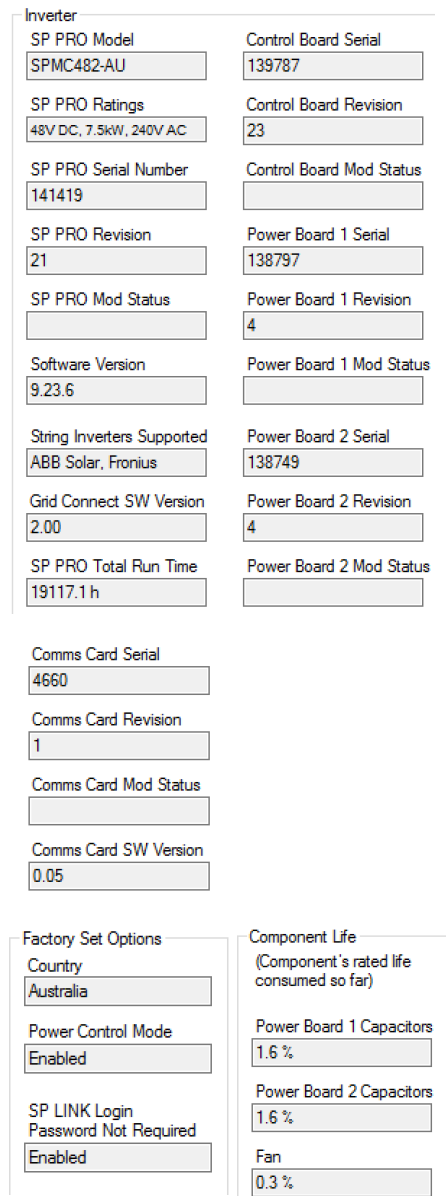

Battery Management Tab

If the SP PRO is connected to and communicating with a battery that has a Battery Management System (BMS) then the BATTERY MANAGEMENT tab provides you with the available battery information.

The BATTERY MANAGEMENT section shows information about the entire battery bank whilst the MODULE STATUS section displays information about the individual battery modules within the battery bank

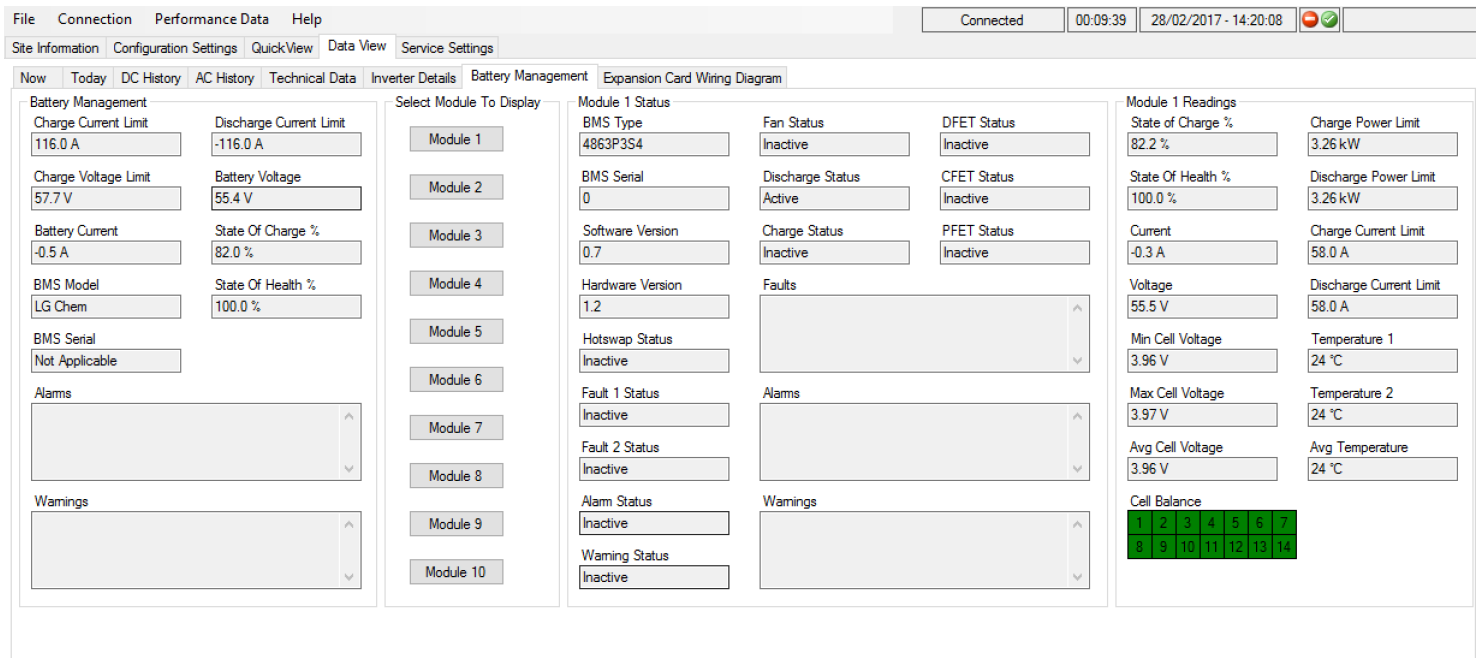

The screenshot shows the 'Battery Management' tab in a software interface. It includes a menu bar (File, Connection, Performance Data, Help) and a status bar (Connected, 00:09:39, 28/02/2017 - 14:20:08). The main content area is divided into several sections:

- Battery Management:** Displays Charge Current Limit (116.0 A), Discharge Current Limit (-116.0 A), Charge Voltage Limit (57.7 V), Battery Voltage (55.4 V), Battery Current (-0.5 A), State Of Charge % (82.0%), BMS Model (LG Chem), State Of Health % (100.0%), BMS Serial (Not Applicable), Alarms, and Warnings.
- Select Module To Display:** A list of buttons for Module 1 through Module 10.
- Module 1 Status:** Shows BMS Type (4863P3S4), BMS Serial (0), Software Version (0.7), Hardware Version (1.2), Hotswap Status (Inactive), Fan Status (Inactive), Discharge Status (Active), Charge Status (Inactive), Faults, Alarms, Warnings, Alarm Status (Inactive), and Warning Status (Inactive).
- Module 1 Readings:** Displays State of Charge % (82.2%), Charge Power Limit (3.26 kW), State Of Health % (100.0%), Discharge Power Limit (3.26 kW), Current (-0.3 A), Charge Current Limit (58.0 A), Voltage (55.5 V), Discharge Current Limit (58.0 A), Min Cell Voltage (3.96 V), Temperature 1 (24 °C), Max Cell Voltage (3.97 V), Temperature 2 (24 °C), Avg Cell Voltage (3.96 V), Avg Temperature (24 °C), and a Cell Balance grid.

Charge Current Limit: The maximum charge current allowed at the time

Discharge Current Limit: The maximum discharge charge current allowed at the time

Charge Voltage Limit: The maximum charge voltage allowed at that time

Battery Current: The battery current at that time. Positive current is charging, negative is discharging.

State of Charge: The battery SoC as read from the BMS.

BMS Model: The model number of the BMS or battery connected to the SP PRO

State of Health Indicates how much of the battery has been used.

Alarms and Warnings: Displays any alarms or warnings generated by the BMS.

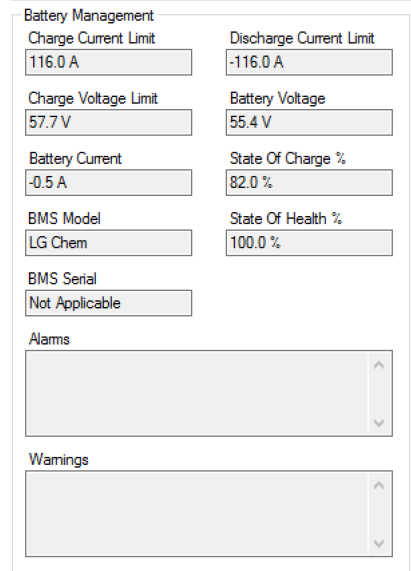

This block shows a detailed view of the Battery Management section. It includes the following parameters:

- Charge Current Limit: 116.0 A
- Discharge Current Limit: -116.0 A
- Charge Voltage Limit: 57.7 V
- Battery Voltage: 55.4 V
- Battery Current: -0.5 A
- State Of Charge %: 82.0 %
- BMS Model: LG Chem
- State Of Health %: 100.0 %
- BMS Serial: Not Applicable
- Alarms: (Empty list)
- Warnings: (Empty list)

MODULE STATUS

The module status section provides advance diagnostic information about the battery system and is used for advanced diagnoses of any faults. It is only available when there are more than one battery module connected into the system and when the BMS has the facility to provide the information. This section is greyed out when this information is not available from the BMS.



Powerchain Tab

The information in this tab is only available when the SP PRO inverters are configured as a Powerchain system. It shows a summary of live data for all of the phases on one tab. This is particularly useful for looking at the overall performance of a three phase or split phase Powerchain SP PRO system.

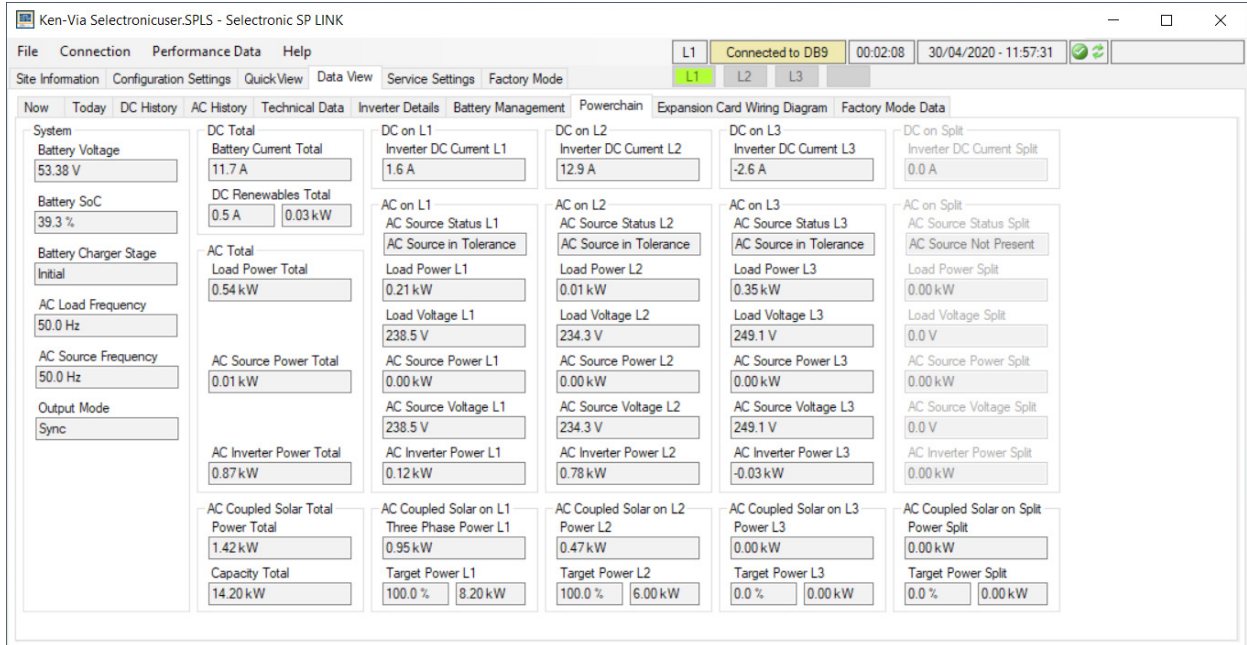

System - This section displays information applicable for the entire system.

DC Total - This section shows the Total battery current (Battery Current Total) and the total DC coupled renewable current (DC Renewable Total). The DC renewable Total is the total of all current shunts configured as either Solar, Wind or Hydro.

AC Total - Gives the total AC power readings for the system.

AC coupled Solar Total - Is the total of all the installed managed AC coupled solar in the system.

DC on L1, DC on L2, DC on L2, DC on Split - Gives the contribution of DC current from each of the phases in the system. Only the applicable phases are displayed.

AC on L1, AC on L2, AC on L3, AC on Split - Gives the contribution of AC power from each of the phases in the system. Only the applicable phases are displayed.

AC coupled Solar on L1, AC coupled Solar on L2, AC coupled Solar on L3, AC coupled Solar on Split - Gives the contribution of managed AC coupled solar from each of the phases in the system. Only the applicable phases that have managed AC coupled solar installed are displayed.



Any Generic AC couple Solar generation will not be displayed on the tab. Where Generic AC coupled Solar is installed, the AC Load power readings will be net of any AC couple Generic Solar being generated at that particular time.

For more detailed information on each of the readings see information under the “Now tab” heading.

Expansion Card Wiring Diagram Tab

The Expansion Card Wiring Diagram shows you how the input and output functions are programmed and allocated in the SP PRO. This display is only active when the are connected to the SP PRO.

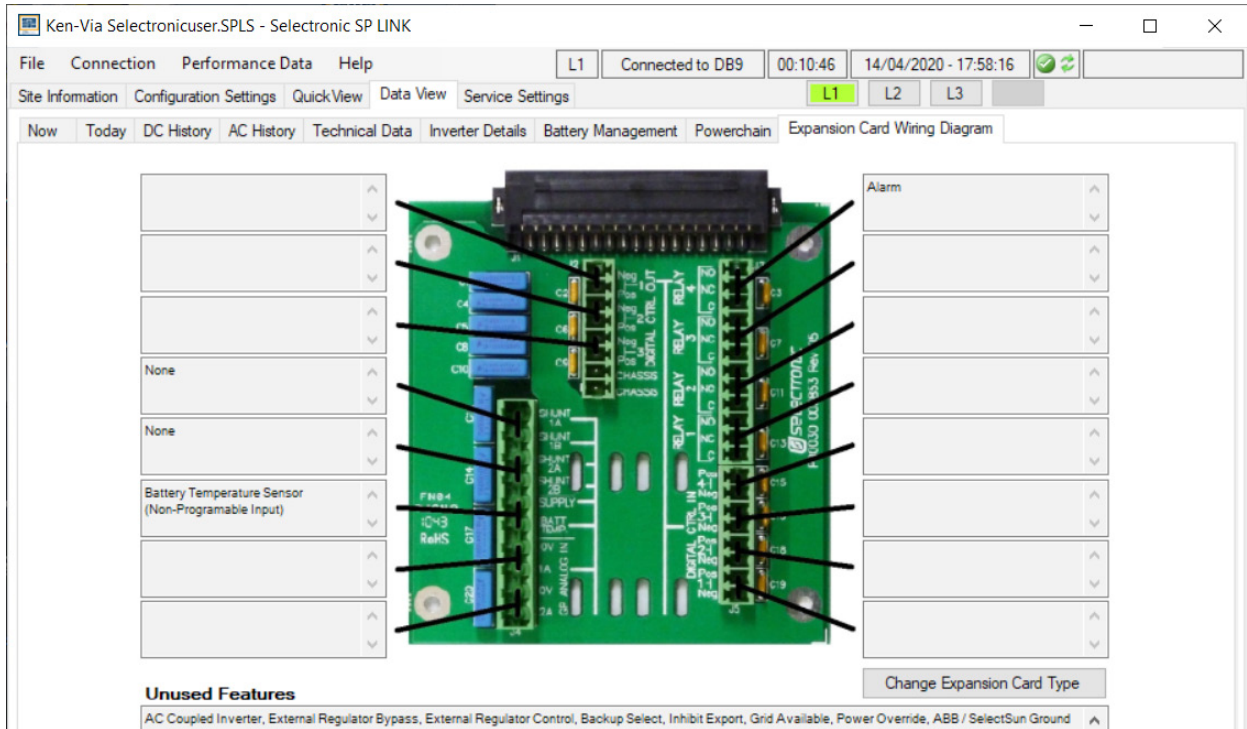

The Unused Features display lists all input and output functions that have not been allocated to an input or output.

Expansion card picture may vary depending on SP PRO model. Click Change Expansion Card Type to suit the model.



BLANK PAGE



Service Settings



Certain readings within the SP PRO must be correctly configured at the time of the original setup. These include the time and date, an approximation of the state of charge and that the current shunts are zeroed.

Time and date

To ensure that various timed functions within the SP PRO, such as generator run schedules, perform as expected it is important to have the correct date and time recorded in the SP PRO. You have the option of automatically uploading the time and date from the computer – including the facility to allow for an offset if the computer is set to a different time zone to the area of installation – or to manually set the time and date.

If you are adjusting the date manually click on the circle adjacent to MANUALLY SET DATE / TIME and use the drop down menu to select the correct date. The time can be set by clicking on the hour or minute section and use the up/down arrows to adjust.

When you have completed adjustment click on SET SP PRO TIME to record the change.

Set SP PRO date/time

SP PRO's Present Date and Time

Date [dd/mm/yyyy]
26/07/2014

Time [hh:mm]
14:31:00

Use Computer Date and Time with Offset

Offset
[hh:mm]
00:00

Manually Set Date and Time

SP PRO Date
[dd/mm/yyyy]
13/08/2009

SP PRO Time
[00:00 - 23:59]
14:27

Set SP PRO Time

Battery SoC

When first setting up the SP PRO an initial estimation of the state of charge must be programmed to enable the SP PRO to facilitate all the functions that are determined by the state of charge measurement from the first day. As the period of operation increases any small error from the original estimation will be corrected. This function is not used when the SP PRO is communicating with a battery as the SoC is read directly from the BMS.

Login Password

The LOGIN PASSWORD is only used when connecting to the SP PRO. A separate password is used to change configuration settings (Settings Password). If you are concerned that the default login password does not provide the level of security for any access to the SP PRO, you can change the Login Password in the SP PRO to one that is uniquely yours.

Like the Settings Passcode, if the Login Password is lost or forgotten it can only be reset by a procedure that requires someone to be on site.

SP LINK will automatically update the Connection settings in Site Information when you set the new Login Password.

Settings Passcode

The SETTINGS PASSCODE is only used to change configuration settings within the SP PRO. A separate passcode (Login Passcode) is used to connect to the SP PRO. If you are concerned that the standard SETTINGS PASSCODE does not provide the level of security you desire for changing SETTINGS, you can change the passcode in the SP PRO to one that is uniquely yours.



Please note that if this Settings Passcode is lost or forgotten it can only be reset by a procedure that requires someone to be on site.

If you require assistance resetting the passcode please consult an Accredited Integrator.

Reset SoC

Present SoC
98.0 %

New SoC
[1.0 - 99.9 %]
85.0

Set SoC

Login Password

Type New Password
[up to 32 character long]

Set Login Password

Settings Passcode

Type New Passcode
[1 - 65535]

Retype New Passcode

Set Passcode

Request Battery Equalise

The BATTERY EQUALISE display shows whether the SP PRO will perform an equalise charge when it next achieves Float (Equalise Pending). Pressing the button will toggle between Equalise Pending and No Equalise Pending. Pressing the button will also stop a current Equalise process.

Battery Equalise

Present Equalise State

Change Equalise State

Setting Charge Efficiency Index

The Charge Efficiency Index will automatically adjust itself in the SP PRO but a number of faults in the installation could cause it to become erroneous (including poorly calibrated or installed DC current shunt or failing batteries). For a correctly installed system with new batteries the index should be between 0.900 and 1.000. If it is a long way out of range, rectify the system fault then reset it back to 0.950.

Charge Efficiency Index

Present Value

0.969

New Value
[0.600 - 1.200]

0.950

Set Efficiency Index

Zero Shunts

To accurately measure and calculate inputs and outputs to and from the batteries the SP PRO needs to start its measurements knowing what is Zero. To set this parameter you must ensure all inputs and outputs are switched off – that is no solar, wind or other inputs coming into the system and all DC loads are switched off – then the ZERO SHUNT 1 and ZERO SHUNT 2 buttons should be pressed.

The figures above the buttons indicate what the on board computer in the SP PRO perceives the relative current to be before zeroing.

Shunts

Shunt 1 Current
(Shunt 1)

Disabled

Zero Shunt 1

Shunt 2 Current
(Shunt 2)

Disabled

Zero Shunt 2

Fan Type

The cooling fan within the SP PRO is a long life, high quality component. As the control section of the SP PRO calculates the hours of life left in the fan (along with other components) it is important that the fan – when it is eventually necessary – is replaced by an authorised spare part. However we are aware that components become obsolete and other fans may need to be used, so we have allowed settings for 4 different fan types. These settings are based around all the fan types available at this time and we will clearly mark any replacement fans with their fan type as they become available.

Fan

Present Fan Type

0

New Fan Type
[0 - 0]

0

Set Fan Type

Fan Life

0.0 %

Reset Fan Life

Expansion Card

The current status of the EXPANSION CARD is displayed. The SP PRO can be set to use (Enabled) all the connected functions from the expansion card like shunts and battery temperature sensor or to ignore (Disabled) them. By default the Expansion Card is enabled.

Expansion Card

Present State

Enabled

New State
[Enabled, Disabled]

Enabled

Set Exp. Card State

AC Solar Link Test

Used for diagnostic of the communications link between the Selectronic Certified grid inverter(s) and the SP PRO in a managed AC coupled installation. AC solar Link Test provides a count of any errors in the link.

When the system installation is complete and all inverters are powered up and running, click “Reset Counters” then wait for 5 minutes. All connected grid inverters should ideally read 0 showing there are no issues with the communications link. A link error count of 4 or less per minute is acceptable although it is recommended that the installation be checked to ensure there are no issues such as the incorrect setting of the RS485 termination resistor on either the SP PRO or grid inverters.

AC Solar Link Test

Errors or non-responses from grid-tie inverters can indicate quality of link.

Counting while grid tie inverter is off is normal.

Link #1

Link #2

Link #3

Link #4

Link #5

AC Safety Monitor

The AC INPUT SAFETY MONITOR detects the loss of the earth/neutral link in the AC Source input to the SP PRO and instantly disconnects the SP PRO from the AC Source whether it be a generator or the mains grid. This important safety feature is included as secondary protection when the AC Source is connected via a removable plug to the generator or mains grid.



The primary protection for a plug in AC Source must be a shrouded plug that prevents contact with the plug terminals when removed from the socket.

This feature should only be disabled if the AC Source is hard wired to the SP PRO and the wiring configuration will trip the AC Safety Monitor. To disable this feature:

1. Set the New Monitor State to Disabled then click Set Monitor State. Present Monitor state for all SP PRO inverters in the Powerchain system will change to Disabled.
2. Set the EN - DISCONNECT switch within each of the SP PRO inverters to Disable (DS). The State of Actual Switch field will change to Disabled



Never disable this feature unless the AC Source is hard wired to the SP PRO..

AC Input Safety Monitor

Present Monitor State
Disabled

New Monitor State
[Enabled, Disabled]
Disabled

State of Actual Switch

1	2	3	4
5	6	7	8
9	10	11	12

WARNING:
The "E-N DISCONNECT" slide switch position and "AC Input Safety Monitor" state should only be altered in limited situations.
A hazardous situation may result.

Read and understand the relevant section of the SP LINK manual or consult a Selectronic accredited installer before changing the switch position or the state of the

[Click here to view relevant section of the manual.](#)



Setting For Poor Grid Quality

When the SP PRO is connected and synchronised to an external AC Source (grid or generator), it is actively improving the quality of the AC Source waveform. If the AC Source waveform is very distorted the SP PRO may shutdown from a “Synchronous Overload Shutdown”. Setting the **Grid Quality** to **Poor** or **unmonitored** will reduce the sensitivity to this distortion and allow the SP PRO to operate as normal.

Sync Overload Shutdown

Present Grid Quality
Normal

New Grid Quality
[Normal, Poor]
Normal

Schedule Restart

Sets the time when the SP PRO will perform an internal restart. This is normally used in Off Grid systems, after new firmware has been loaded into the SP PRO. A restart would normally cause loss of power so this can be set to occur at a time that is least convenient to the customer, say 2:00 am.

Scheduled Reset

Present Schedule

New Schedule
[00:00 - 23:59]

06:08

Installer Only Service Settings

The settings in this group can only be changed WITH an **Installer Only Code** OR within the first four (4) hours of the SP PRO operation.

Normally these settings are configured at installation and would remain unchanged. If a change is required after the system has been running for longer than four hours, an **Installer Only Code** is required. Once entered, the code unlocks these settings for 5 minutes. A code is available from Selectronic to bona fide installers ONLY.

ANTI ISLANDING SENSITIVITY reduces the active anti islanding threshold in the SP PRO to provide compatibility with some off grid and micro grid systems. This setting must never be changed for grid connected systems that require AS4777.2-2020 compliance. The active anti islanding can be turned off completely by setting the value to 0%.

Installer Only Service Settings

These settings are accessible for the first four hours of inverter run time, after which access is by a code made available only to installers.

Installer Only Code

<p>Anti-Islanding Sensitivity</p> <p>Present Value</p> <p>100 %</p> <p>New Value</p> <p>[0 - 100 %]</p> <p>100 <input type="button" value="v"/></p> <p><input type="button" value="Set Sensitivity"/></p>	<p>Export Limit</p> <p>Present Value</p> <p>No Limit</p> <p>New Value</p> <p>[0.0 - 5,000.0 kW per phase]</p> <p>5000.0 <input type="button" value="v"/></p> <p><input type="button" value="Set Export Limit"/></p>	<p>Sync L1 Phase Only</p> <p>Present State</p> <p>Disabled</p> <p>New State</p> <p>[Enabled, Disabled, Backup]</p> <p>Disabled <input type="button" value="v"/></p> <p><input type="button" value="Set L1 Phase Sync"/></p>
<p>Total Support Limit</p> <p>Present Value</p> <p>No Limit</p> <p>New Value</p> <p>[0.0 - 5,000.0 kW per phase]</p> <p>5000.0 <input type="button" value="v"/></p> <p><input type="button" value="Set Support Limit"/></p>	<p>Allow Power Override</p> <p>Present State</p> <p>Disabled</p> <p>New State</p> <p>[Enabled, Disabled]</p> <p>Disabled <input type="button" value="v"/></p> <p><input type="button" value="Set Power Override"/></p>	<p>AEMO Ride Through</p> <p>Present State</p> <p>Disabled</p> <p>New State</p> <p>[Enabled, Disabled]</p> <p>Disabled <input type="button" value="v"/></p> <p><input type="button" value="Set Ride Through"/></p>

TOTAL SUPPORT LIMIT limits the maximum total power that can be taken from the battery plus the managed AC Coupled Solar to support the customer's load. For example, if TOTAL SUPPORT LIMIT is set to 5.0kW and there is 3kW of Solar being produced at the time, only 2kW of support power will be available from the battery, giving a total of 5.0kW. In multi-phase systems this setting is per phase.

EXPORT LIMIT is the same function as a Factory Set Export Limit with the exception that it can be set by the installer. If the EXPORT LIMIT is set higher than any Factory Set Export Limit then the latter will apply. In multi-phase systems this setting is per phase.

ALLOW POWER OVERRIDE enables the Power Override function within the Solar Hybrid Schedules. When set, the Power Override setting will take a constant power (according to the Power Override setting in the active Solar Hybrid schedule) from the batteries and push it out the AC Load port on the SP PRO.

SYNC L1 PHASE ONLY. This setting allows for the use of a single phase AC Source (generator or grid) to be connected to the L1 phase of a split phase (SWER line) or three phase Powerchain system. Two settings are available being Enabled and Enabled by Backup Select.

Enabled: Used in a three phase off grid system with a single phase generator or in a single phase grid connected system feeding a three phase SP PRO configuration to provide three phase power (Single phase to three phase converter). This setting must never be used for three phase grid connected systems that requires AS4777.2-2020 compliance.

Enabled by Backup Select: For a multi phase (split phase or three phase) grid connected system where a single phase generator is used with the Grid Fail Generator Backup option. The system will remain compliant to the grid connect standard by only allowing the Sync to L1 Phase Only function during a generator backup event.



AEMO RIDE THROUGH. This setting allows compliance to the Low Voltage Ride Through as specified by AEMO in September 2020. This setting must be enabled when required by the local power network. For Example this function is required by South Australian Power Networks (SAPN) so any grid connected system connected within South Australia must have this setting enabled.

Appendix One Alert Messages



The SP PRO is continuously measuring and monitoring the power system to ensure correct system operation at all times. When the SP PRO detects a problem with the power system it then:

1. Displays a message in the “Attention Required” area in SP LINK (In the Data View - Now tab).
2. Creates an entry in its data log memory. This data can be downloaded from the SP PRO and viewed in the EVENTS tab of the Performance Data Viewer.

The table in this section outlines all the SP PRO ALERT type event messages, the most likely cause and possible remedies.



Only the ALERT events are listed - They are listed in alphabetical order.

Alerts and attention required messages	Meaning and diagnostic	Action	Configuration settings>
AC Source - Safety Monitor Alert - Neutral and Earth are not at same potential	The inverter has detected either a poor EN connection or missing EN connection in the AC Source wiring.	Call system installer to check the voltage between the Earth and Neutral of the AC Source connections at the Inverter. If voltage > 1VAC then track down the wiring fault.	Service Settings > AC Input Safety Monitor (group).
AC Source - Safety Monitor Alert cleared	Above condition has cleared		
Battery - Hi Battery Alert	Battery voltage has risen above the Hi Battery Alert Voltage	Call system installer to check the correct operation of any DC charge controllers. Check communications between SP PRO and grid inverter in Managed AC coupled system. Check all battery system connections and check for faulty cells in battery bank.	Battery > Hi Battery Alert
Battery - Hi Battery Alert Clear	Battery voltage has dropped below the Hi Battery Alert Clear Voltage clearing the above condition		Battery > Hi Battery Alert Clear



Alerts and attention required messages	Meaning and diagnostic	Action	Configuration settings>
Battery - Mid Point Fault - Outside Range after Equalise	Battery Mid Point Voltage is outside Mid Point Range after an equalise has been performed. Battery bank may have faulty cell.	Call installer to check for faulty cells in the battery bank or for poor battery connections between cells and between battery bank and SP PRO	Battery > Midpoint Monitoring
Battery - Mid Point Fault cleared	Above condition has cleared		
Battery - Outside Mid Point Range	Battery Mid Point Voltage is outside Mid Point Range. Battery bank may have faulty cell or need equalise	Initiate an equalise charge from the Service Settings tab in SP LINK (Battery Equalise section). If problem persists then call installer to check for faulty cells in the battery bank or for poor battery connections between cells and between battery bank and SP PRO.	Battery >- Mid Point Range.
Battery - Within Mid Point Range	Above condition has cleared		Battery > Mid Point Range.
Battery - Over Temp Protection Alert	The battery temperature has risen above the Over Temp Protection limit	Immediately turn SP PRO to IDLE (long press of ON button on front panel). Call installer to check battery temperature sensor is correctly installed, batteries charge parameters are correct and that all charging sources are operating correctly. Installer to check that there are no faulty cells in the battery bank and to take measures to reduce battery ambient temperature.	Battery > Over Temp Protection > Limit Charge Above.
Battery - Over Temp Protection Alert cleared	The battery temperature has dropped below the Over Temp Protection limit		Battery > Over Temp Protection > Limit Charge Above..
Battery Management - Alarm	The Battery Management System within the battery has sent an alarm to the SP PRO		
Battery Management - Alarm Cleared	The above alarm has cleared	Look in the Data View > Battery Management tab for details about the fault.	
Charger - Battery Capacity Alert - Provided 120% Capacity and voltage target not achieved	Battery is not charging as fast as expected. The battery SoC has risen but the battery voltage is not matching the expected SoC	Call your installer to check battery condition and for shorted or weak cells.	Battery Capacity
Charger - Battery Capacity Alert cleared - Voltage target achieved	The expected battery voltage target has now been achieved. Batteries now charging as expected.		
Generator Controller - Generator Fault Alert - Stop generator	The Generator Fault input has been asserted. Generator will be stopped if it is running	Call appropriately qualified personnel to diagnose and rectify the generator fault.	Inputs/Outputs > Generator fault input
Generator Controller - Generator Fault Alert cleared	The Generator Fault input has been cleared. Generator will start again as required		Inputs/Outputs - Generator fault input
Generator Controller - Low Fuel Alert	The Generator Low Fuel input has been asserted. Generator will continue to run	Fill generator fuel tank.	Inputs/Outputs - Generator Low Fuel input



Alerts and attention required messages	Meaning and diagnostic	Action	Configuration settings>
Generator Controller - Low Fuel Alert cleared	The Generator Low Fuel input has been cleared		Inputs/Outputs - Generator Low Fuel input
Generator Controller - No Fuel Alert - Stop generator	The Generator No Fuel input has been asserted. Generator will be stopped if it is running	Fill generator fuel tank	Inputs/Outputs - Generator No Fuel input
Generator Controller - No Fuel Alert cleared	The Generator No Fuel input has been cleared. Generator will start again as required		Inputs/Outputs - Generator No Fuel input
Generator Controller - Stopped due to no AC Volts Fault	The Inverter has stopped the generator as there is no AC volts present at the inverter. Caused by either a wiring fault, tripped CB or faulty generator.	Call your installer or appropriately qualified personnel to check the AC Source voltage at the SP PRO when the generator is running. If no voltage is present, then they need to trace the voltage back to the generator to find the wiring fault.	
Generator Controller - Stopped due to no AC Volts Fault Cleared	Above condition has cleared		
Inverter - AC Source out of phase On	Only applies to three phase or Split phase systems. The phase rotation or phase sequence on the AC Source input is incorrect. Caused by wiring fault on the AC Source input - Phase rotation or phase angle is incorrect.	Call your installer or appropriately qualified personnel to check all AC Source wiring and AC Source supply for correct voltage, phase and phase rotation.	
Inverter - AC Source out of phase Off	Above condition has cleared		
Inverter - AC Source out of tolerance Beeper On	When the AC Source Disconnect Beeper is enabled and the AC Source is outside the set limits (as set in AC Source > AC Input tab setting) this alarm will be raised	Normal operation. Alerting the user that the grid supply has either failed or it is too high or too low.	System > AC Source Disconnect Beeper
Inverter - AC Source out of tolerance Beeper Off	Above condition has cleared		
Inverter - DC Shutdown	Inverter has shut down from Low Battery Voltage	Firstly, reduce all the loads on the system to the minimum. Check that all the charging sources such as PV solar and generator charging are functioning correctly. Call installer to check for faulty cells in the battery bank or for poor battery connections between cells and between battery bank and SP PRO	Inverter-DC shutdown (group) > Inverter 0% load and Inverter 100% Load
Inverter - DC Shutdown cleared - Recovery Voltage reached	The battery voltage has risen above the shut down voltage to the Recovery Voltage		Inverter-DC shutdown (group) > Recovery Voltage
Inverter - Low AC Alert	The AC output of the inverter is low, normally due to power overload. Inverter shutdown is imminent.	Start turning off loads and if problem persists with little or no load on the system, call your installer to check for overload or short circuits on the AC load circuits.	



Alerts and attention required messages	Meaning and diagnostic	Action	Configuration settings>
Inverter - Low AC Alert cleared	The AC output of the inverter is now OK. Inverter will not shutdown.		
Inverter - Low AC Shutdown	The AC output of the inverter was low, normally due to power overload and Inverter has shutdown	Start turning off loads and if problem persists with little or no load on the system, call your installer to check for overload or short circuits on the AC load circuits.	
Inverter - Low AC Shutdown cleared	The AC output of the inverter is now OK. Inverter will start again.		
Inverter - Low Battery Voltage Alert	Battery voltage getting close to Shutdown voltage and shutdown is imminent.	Firstly, reduce all the loads on the system to the minimum. Check that all the charging sources such as PV solar and generator charging are functioning correctly. If problem persists, call installer to check for faulty cells in the battery bank or for poor battery connections between cells and between battery bank and SP PRO	Inverter-DC shutdown (group) > Inverter 0% load and Inverter 100% Load
Inverter - Low Battery Voltage Alert cleared	The battery voltage has risen above the to Recovery Voltage		Inverter-DC shutdown (group)
Inverter - Low SoC Alert	Battery SoC is getting close to Shutdown voltage and shutdown is imminent. The loads on the system maybe exceeding the charging source	Firstly, reduce all the loads on the system to the minimum and start your generator. Check that all the charging sources such as PV solar and generator charging are functioning correctly.. If there is a problem with one of the charging sources then contact your installer. If all is OK then you will need to use less power or run the generator more often.	Inverter-DC shutdown (group) > Shutdown SoC
Inverter - Low SoC Alert Cleared	The battery SoC and voltage has risen above the to Recovery level		Inverter-DC shutdown (group) > Shutdown SoC and Recovery Voltage
Inverter - Shutdown Input Active	When programmed within the SP PRO, this input is active and the inverter is shutdown and is not producing any AC output.	Determine the source of the input and remedy the fault within that source	Input / Outputs > Shutdown Input
Inverter - Shutdown Input Active Cleared	The Shutdown input is no longer inactive and the inverter will come back on.		
Inverter - SoC Shutdown	Inverter has shut down from Low SoC	Firstly, reduce all the loads on the system to the minimum and start your generator. Check that all the charging sources such as PV solar and generator charging are functioning correctly. If there is a problem with one of the charging sources then contact your installer. If all is OK then you will need to use less power or run the generator more often.	Inverter-DC shutdown (group) > Inverter 0% load and Inverter 100% Load



Alerts and attention required messages	Meaning and diagnostic	Action	Configuration settings>
Inverter - SoC Shutdown cleared	The battery SoC and voltage has risen above the to Recovery level		Inverter-DC shutdown (group) > Recovery Voltage
Powerchain - Alert Alarm on Phase L2		Check L2 Dataview > Now for alarm details	
Powerchain - Alert Alarm on Phase L2 Cleared	Above condition has cleared		
Powerchain - Shutdown Alarm on Phase L2		Check L2 Dataview > Now for alarm details	
Powerchain - Shutdown Alarm on Phase L2 Cleared	Above condition has cleared		
Powerchain - Critical Alarm on Phase L2		Check L2 Dataview > Now for alarm details	
Powerchain - Critical Alarm on Phase L2 Cleared	Above condition has cleared		
Powerchain - AC Source Alarm on Phase L2		Check L2 Dataview > Now for alarm details	
Powerchain - AC Source Alarm on Phase L2 Cleared	Above condition has cleared		
Powerchain - Alert Alarm on Phase L3		Check L3 Dataview > Now for alarm details	
Powerchain - Alert Alarm on Phase L3 Cleared	Above condition has cleared		
Powerchain - Shutdown Alarm on Phase L3		Check L3 Dataview > Now for alarm details	
Powerchain - Shutdown Alarm on Phase L3 Cleared	Above condition has cleared		
Powerchain - Critical Alarm on Phase L3		Check L3 Dataview > Now for alarm details	
Powerchain - Critical Alarm on Phase L3 Cleared	Above condition has cleared		
Powerchain - AC Source Alarm on Phase L3		Check L3 Dataview > Now for alarm details	
Powerchain - AC Source Alarm on Phase L3 Cleared	Above condition has cleared		
Powerchain - Alert Alarm on Phase Split		Check Split Dataview > Now for alarm details	
Powerchain - Alert Alarm on Phase Split Cleared	Above condition has cleared		



Alerts and attention required messages	Meaning and diagnostic	Action	Configuration settings>
Powerchain - Shutdown Alarm on Phase Split		Check Split Dataview > Now for alarm details	
Powerchain - Shutdown Alarm on Phase Split Cleared	Above condition has cleared		
Powerchain - Critical Alarm on Phase Split		Check Split Dataview > Now for alarm details	
Powerchain - Critical Alarm on Phase Split Cleared	Above condition has cleared		
Powerchain - AC Source Alarm on Phase Split		Check Split Dataview > Now for alarm details	
Powerchain - AC Source Alarm on Phase Split Cleared	Above condition has cleared		
Powerchain - No comms to Phase Manager L2	The System Manager (L1 manager) has lost SYNC comms with L2 Phase Manager.	Check SYNC connections and cables between inverters in Powerchain.	
Powerchain - No comms to Phase Manager L2 Cleared	Above condition has cleared		
Powerchain - No comms to Phase Manager L3	The System Manager (L1 manager) has lost SYNC comms with L3 Phase Manager.	Check SYNC connections and cables between inverters in Powerchain.	
Powerchain - No comms to Phase Manager L3 Cleared	Above condition has cleared		
Powerchain - No comms to Phase Manager Split	The System Manager (L1 manager) has lost SYNC comms with Split Phase Manager.	Check SYNC connections and cables between inverters in Powerchain.	
Powerchain - No comms to Phase Manager Split Cleared	Above condition has cleared		
Powerchain - No comms to Phase Worker	The Phase Manager has lost SYNC comms with one of its workers	Check SYNC connections and cables between inverters in Powerchain.	
Powerchain - No comms to Phase Worker cleared	Above condition has cleared		
Powerchain - No comms to Phase Manager	The Phase Worker has lost SYNC comms with its Phase Manager	Check SYNC connections and cables between inverters in Powerchain.	
Powerchain - No comms to Phase Manager cleared	Above condition has cleared		
Powerchain - Alert Alarm on L1		Dataview > Now will also contain alarm details	
Powerchain - Alert Alarm on L1 Cleared	Above condition has cleared		
Powerchain - Shutdown Alarm on L1		Dataview > Now will also contain alarm details	

Alerts and attention required messages	Meaning and diagnostic	Action	Configuration settings>
Powerchain - Shutdown Alarm on L1 Cleared	Above condition has cleared		
Powerchain - Critical Alarm on L1		Dataview > Now will also contain alarm details	
Powerchain - Critical Alarm on L1 Cleared	Above condition has cleared		
Powerchain - AC Source Alarm on L1		Dataview > Now will also contain alarm details	
Powerchain - AC Source Alarm on L1 Cleared	Above condition has cleared		
Powerchain - Phase Worker not modulating	One of the Phase Masters workers is not providing power output or charging.	Check AC circuit breakers and SYNC cables.	
Powerchain - Phase Worker not modulating Cleared	Above condition has cleared		
Powerchain - Phase Manager not modulating	One of the Phase Masters is not providing power output or charging.	Check AC circuit breakers and SYNC cables.	
Powerchain - Phase Manager not modulating Cleared	Above condition has cleared		
Service - AC Source Safety Monitor State does not match State of Actual Switch	The AC safety monitor switch in the inverter does not match the setting in the Service Settings.	Contact your installer to either change to position of the safety monitor switch or change the setting in the Service Settings using SP LINK	Service Settings > AC Input Safety Monitor (group).
Service - AC Source Safety Monitor State matches State of Actual Switch	Above condition has cleared		
Service - Fan Alert - Fan not spinning	Cooling Fan is not spinning due to obstruction or failure	Power down the SP PRO inverter following the shutdown procedure provided beside the inverter. Remove fan guard and check fan for obstructions. Check fan can spin freely. If problem persists, contact your installer to install a new fan.	-
Service - Fan Alert cleared - Fan spinning or not required	Cooling Fan is now spinning again.		
Service - Fan Filter Alert - Clean Filter	Recommend that the cooling fan filter be cleaned to maintain cooling efficiency	Clean fan filter in the base of the unit with a soft brush to remove any dirt or obstruction.	
Service - Fan Filter Alert cleared - Filter clean button pressed	Above condition has cleared		
Service - Fan Life Alert - Life at or above 100% - Replace Fan	Recommend that the cooling fan be replaced to prevent unexpected failure.	Contact your installer for a replacement fan.	
Service - Fan Life Alert cleared - Life reset to 0.	Above condition has cleared		



Alerts and attention required messages	Meaning and diagnostic	Action	Configuration settings>
Service - Fan Speed Alert - Speed lower than expected - Check Fan	Cooling fan is running too slow. Check for fan fault or obstruction.	Clean fan filter in the base of the unit with a soft brush to remove any dirt or obstruction. If problem persists then power down the SP PRO inverter following the shutdown procedure provided beside the inverter. Remove fan guard and check fan for obstructions. Check fan can spin freely. If problem still persists, contact your installer to install a new fan.	
Service - Fan Speed Alert cleared - Speed as expected	Above condition has cleared		
Service - Output Capacitor Life Alert - Replace capacitors	The Output filter Capacitors are close to the end of their service life. Recommend Inverter returned to service for capacitor replacement.	Contact Selectronic service at http://www.selectronic.com.au/service/	
Service - Output Capacitor Life Alert cleared	Above condition has cleared		
Service - Output Capacitor life end - Replace capacitors	The Output Capacitors within the SP PRO have reached end of life. Return Inverter to service for capacitor replacement.	Contact Selectronic service at http://www.selectronic.com.au/service/	
Service - Output Capacitor life end alert cleared.	Above condition has cleared		
Service - Power Module 1 Capacitor Life Alert - Life at or above 95%	The internal capacitors have reach the end of their rated life. Recommend inverter returned to Service for capacitor replacement.	Contact Selectronic service at http://www.selectronic.com.au/service/	
Service - Power Module 1 Capacitor Life Alert cleared	Above condition has cleared		
Service - Power Module 2 Capacitor Life Alert - Life at or above 95%	The internal capacitors have reach the end of their rated life. Recommend inverter returned to Service for capacitor replacement.	Contact Selectronic service at http://www.selectronic.com.au/service/	
Service - Power Module 2 Capacitor Life Alert cleared	Above condition has cleared		
System - AC coupled frequency ramp invoked	<p>1. Managed AC coupled system - Indicates loss of control so Inverter ramps its output frequency to 55 Hz to cause a AS4777 disconnect to “kick off” the AC Coupled Inverters</p> <p>2. Generic AC coupled system – Normal operation when grid has failed and inverter running stand alone. Occurs when the charge target current or voltage is exceeded.</p>	.If you have a Managed AC coupled system with a Selectronic Certified grid inverter, contact your installer to come and check all the RS485 cables and wireless devices between the SP PRO inverter and the Selectronic Certified grid inverter.	
System - AC coupled frequency ramp invoked off	Above condition has cleared		



Alerts and attention required messages	Meaning and diagnostic	Action	Configuration settings>
System - AC Coupled frequency ramp invoked (1,2,3,4,5,6)	Internal parameter to identify ramp trigger.	No Action Required. Selectronic use only.	
System - AC Coupled Inverter - Invalid device detected	When either a three phase managed AC coupled inverter is connected to an SP PRO that is configured for a single phase OR visa versa.	Correct the <i>Configuration Setting > System > String Inverter</i> setting to suit the attached string inverter	
System - AC Coupled Inverter - Invalid device detected Cleared	Above condition has cleared		
System - AC Load exceeding AC Source plus Inverter Rating	When the inverter is connected and synchronised to the AC Source, the load on the system is exceeding the rating of the inverter plus the specified AC Source Power limit. Under this condition the AC Source Power limit will be exceeded. This could cause an overload on the AC Source and the load should be reduced.	Turn off some of the loads connected to the system. If you need to continue to use high loads on the system then contact your installer to upgrade the size of your system.	Config. Settings > AC Source Power.
System - AC Load below AC Source plus Inverter Rating	Above condition has cleared		
System - AC Load Voltage Alert - Volts detected from unknown source	There is an AC voltage on the inverter load terminals when the inverter is off. Caused by either a stuck AC contactor or wiring fault.	Contact your installer to remove all connections to the AC load terminals. If Alert persists then your inverter has a stuck contactor and will need a service. Contact Selectronic service at http://www.selectronic.com.au/service/	
System - AC Load Voltage Alert cleared - No volts detected	The above condition has cleared		
System - AC Source Contactor Fault - Contactor stuck open	The AC Source contactor has a fault and has not closed when expected. If an external contactor is installed then there is a fault in this section.	Contact your installer to check all the wiring and components for the external AC contactor and its configuration. If the system does not have an external AC Source contactor and if problem persists, your inverter will need a service. Contact Selectronic service at http://www.selectronic.com.au/service/	
System - AC Source Contactor Fault cleared - was open	Above condition has cleared		
System - Batt Sense Alert - measurement out of range - using internal voltage sense	The Battery Sense / Pre-Charge wiring is not connected or it has a fault. Check Data View > Technical Data > Sense Voltage in SP LINK.	Contact your installer to fix the faulty Battery Sense / Pre-Charge wiring.	
System - Batt Sense Alert cleared - using Batt Sense	Above condition has cleared		



Alerts and attention required messages	Meaning and diagnostic	Action	Configuration settings>
System - Battery Temp sensor open circuit	There is a fault in the battery temperature sensor or its wiring.	Contact your installer to check battery temperature sensor and its wiring. Measure sensor with multi meter approximately 2k ohms at 25C	
System - Battery Temp sensor ok - was open	Above condition has cleared		
System - Battery Temp sensor reading too high	There is a fault in the battery temperature sensor or its wiring.	Contact your installer to check battery temperature sensor and its wiring. Measure sensor with multi meter approximately 2k ohms at 25C	
System - Battery Temp sensor ok - was too high	Above condition has cleared		
System - Battery Temp sensor reading too low	There is a fault in the battery temperature sensor or its wiring.	Contact your installer to check battery temperature sensor and its wiring. Measure sensor with multi meter approximately 2k ohms at 25C	
System - Battery Temp sensor ok - was too low	Above condition has cleared		
System - Battery Temp sensor short circuit	There is a fault in the battery temperature sensor or its wiring.	Contact your installer to check battery temperature sensor and its wiring. Measure sensor with multi meter approximately 2k ohms at 25C	
System - Battery Temp sensor ok - was shorted	Above condition has cleared		
System - Common defaults loaded	The user has initiated a "Load Defaults" from the front panel of the inverter.		
System - Hi Battery Shutdown (AC Coupled) Fault	Only applies to AC coupled systems (Managed or Generic). Inverter has shutdown as a last resort due to high battery voltage. Inverter only shuts down if frequency ramping does not disconnect the AC coupled solar and the high batter voltage persists.	Contact your installer to check Grid inverter (Selectronic Certified or Generic) to see that it disconnects at 55Hz grid frequency. If grid inverter is Selectronic Certified then check RS485 communications between the SP PRO and the grid inverter.	
System - Hi Battery Shutdown (AC Coupled) Cleared	Above condition has cleared		
System - Hi Temperature Alert	The inverter is reaching its maximum operating temperature and about to shut down. Either the load is too high, the air flow is obstructed or the ambient temperature is high.	Turn off some of the appliances connected to the system. Check fan filter in the base of the SP PRO for obstructions. Ensure there is free airflow around the inverter. If problem persists, contact your installer.	
System - Hi Temperature Alert cleared	Above condition has cleared		



Alerts and attention required messages	Meaning and diagnostic	Action	Configuration settings>
System - Hi Temperature Shutdown	The inverter has reached its maximum operating temperature and shut down. Either the load is too high or the air flow is obstructed.	Turn off some of the appliances connected to the system. Check fan filter in the base of the SP PRO for obstructions. Ensure there is free airflow around the inverter. If problem persists, contact your installer.	
System - Hi Temperature Shutdown cleared	Above condition has cleared		
System - AC Coupled Inverter #1 communication Fault	The RS485 communications with AC Coupled Inverter #1 has been lost for longer than 18 hours. It is normal to lose communications overnight when the AC Coupled Inverter shuts down so loss for longer than 18 hours indicates a fault.	Contact your installer to come and check all the RS485 cables and wireless devices between the SP PRO inverter and Selectronic Certified grid inverter.	
System - AC Coupled Inverter #1 communication Fault Cleared	Above condition has cleared		
System - AC Coupled Inverter #2 communication Fault	The RS485 communications with AC Coupled Inverter #2 has been lost for longer than 18 hours. It is normal to lose communications overnight when the AC Coupled Inverter shuts down so loss for longer than 18 hours indicates a fault.	Contact your installer to come and check all the RS485 cables and wireless devices between the SP PRO inverter and the Selectronic Certified grid inverter.	
System - AC Coupled Inverter #2 communication Fault Cleared	Above condition has cleared		
System - AC Coupled Inverter #3 communication Fault	The RS485 communications with AC Coupled Inverter #3 has been lost for longer than 18 hours. It is normal to lose communications overnight when the AC Coupled Inverter shuts down so loss for longer than 18 hours indicates a fault.	Contact your installer to come and check all the RS485 cables and wireless devices between the SP PRO inverter and the Selectronic Certified grid inverter.	
System - AC Coupled Inverter #3 communication Fault Cleared	Above condition has cleared		
System - AC Coupled Inverter #4 communication Fault	The RS485 communications with AC Coupled Inverter #4 has been lost for longer than 18 hours. It is normal to lose communications overnight when the AC Coupled Inverter shuts down so loss for longer than 18 hours indicates a fault.	Contact your installer to come and check all the RS485 cables and wireless devices between the SP PRO inverter and the Selectronic Certified grid inverter.	
System - AC Coupled Inverter #4 communication Fault Cleared	Above condition has cleared		
System - AC Coupled Inverter #5 communication Fault	The RS485 communications with AC Coupled Inverter #5 has been lost for longer than 18 hours. It is normal to lose communications overnight when the AC Coupled Inverter shuts down so loss for longer than 18 hours indicates a fault.	Contact your installer to come and check all the RS485 cables and wireless devices between the SP PRO inverter and the Selectronic Certified grid inverter.	



Alerts and attention required messages	Meaning and diagnostic	Action	Configuration settings>
System - AC Coupled Inverter #5 communication Fault Cleared	Above condition has cleared		
System - Lost SP SYNCH connection On	Only applies to three phase or Split phase systems. Communications link between inverters has been lost.	Contact your installer to check all SYNC leads between SP PRO inverters are plugged in and clicked home. Next try replacing SYNC leads between inverters.	
System - Lost SP SYNCH connection Off	Above condition has cleared		
System - Main DC Supply Cable Open Circuit Fault	The main battery wiring, battery fuse or battery bank has a fault and is not supplying power to the inverter. The battery sense/pre-charge wiring is still OK and turned on.	Contact your installer to check battery bank, ALL DC battery cabling (including inside inverter) and main battery fuses of circuit breaker.	
System - Main DC Supply Cable Open Circuit Fault Cleared	Above condition has cleared		
System - multi-phase system fault forcing shutdown On	Only applies to three phase or Split phase systems. One of the other SP PRO inverters in the system has shut down causing the rest of the inverters to shut down. As soon as the inverter with the fault recovers, all the other inverters come back on.	Check to see which SP PRO inverter is causing the shutdown by checking its alarm status via SP LINK or remote communications. If using SP LINK then check "Attention required" box to determine cause.	
System - multi-phase system fault forcing shutdown Off	Above condition has cleared		
System - multi-phase system fault On	Only applies to three phase or Split phase systems. There is a fault in the inverter reporting this alert.	Check this inverter's alarm status via SP LINK or remote communications. If using SP LINK then check "Attention required" box to determine cause.	
System - multi-phase system fault Off	Above condition has cleared		
System - Off Grid Unit Application defaults loaded	The user has initiated a "Load Defaults" from the front panel of the inverter.		
Service - Output Capacitor Life Alert - Replace capacitor	Output capacitors are approaching End Of Life (EOL). Inverter will continue to run.	Contact Selectronic service at http://www.selectronic.com.au/service/	
Service - Output Capacitor Life Alert cleared	Above condition Cleared		
Service - Output Capacitor life end - Replace capacitors	Output capacitor has reached EOL. Inverter will shut down	Contact Selectronic service at http://www.selectronic.com.au/service/	
Service - Output Capacitor life end Cleared	Above condition cleared.		
System - Permanent Factory defaults loaded	Occurs when the settings become corrupt and factory defaults need to be loaded. Site settings will need to be loaded back into the inverter.	If fault persists, contact your installer.	

Alerts and attention required messages	Meaning and diagnostic	Action	Configuration settings>
System - Power Module - Current Limit Shutdown	There has been a major disturbance in the system and the hardware protection has tripped. Inverter will shutdown momentarily then come back on	An occasional fault of this type is OK. Continuous faults indicate a system wiring fault or a very poor AC Source such as malfunctioning generator. Contact your installer to diagnose and remedy the system fault	
System - Power Module - Current Limit Shutdown cleared	Above condition has cleared		
System - Reset	Normal Reset occurs at power up and after firmware update (Reset buttons).	For a persistent fault, contact your installer.	
System - Sealed Battery Type defaults loaded	The user has initiated a "Load Defaults" from the front panel of the inverter.		
System - Service defaults loaded	The user has initiated a "Load Defaults" from the front panel of the inverter.		
System - Synchronisation Fail - AC Source unsuitable	The connected generator has an unstable voltage or frequency and the inverter cannot synchronise to it. Generator needs repair or replacing.	Contact your installer or generator supplier to carry out a service on the generator or to replace the faulty generator.	
System - Synchronisation Fail - Cleared for retry	Above condition has cleared		
System - Synchronised Overload Shutdown	Inverter has shutdown from over current when connected and synchronised to the AC Source. Caused by a disturbance in the AC Source voltage or distorted AC Source voltage.	Fault indicates a poor AC Source voltage waveform. Contact your installer if continuous faults persist to change the Grid Quality setting in Service Settings to Poor.	Service Settings> Grid Quality
System - Synchronised Overload Shutdown cleared	Above condition has cleared		
System - System Scheduler defaults loaded	Occurs when the settings become corrupt and factory defaults need to be loaded. Site settings will need to be loaded back into the inverter.	If fault persists contact your installer.	
Unit - AC Source Contactor Fault - Contactor stuck closed	The AC Source contactor has a fault and has not opened when expected. If an external contactor is installed then there is a fault in this section.	Contact your installer to check all the wiring and components for the external AC contactor and its configuration. If the system does not have an external AC Source contactor and if problem persists, your inverter will need a service. Contact Selectronic service at http://www.selectronic.com.au/service/	
Unit - AC Source Contactor Fault cleared - was closed	Above condition has cleared		



Alerts and attention required messages	Meaning and diagnostic	Action	Configuration settings>
Unit - AC Source Contactor Fault - Contactor stuck closed - Earth Neutral link not present	The AC Source contactor has a fault and has not opened when expected. This has also caused a EN fault. If an external contactor is installed then there is a fault in this section.	Contact your installer to check all the wiring and components for the external AC contactor and its configuration. If the system does not have an external AC Source contactor and if problem persists, your inverter will need a service. Contact Selectronic service at http://www.selectronic.com.au/service/	
Unit - AC Source Contactor Fault cleared - was closed - EN Link not present	Above condition has cleared		
Unit - AC Source contactor fault - inverter volts detected at AC Source	There are AC volts from the inverter output appearing on the AC Source terminals. Indicates either a fault in the AC Source contactor or a fault in the system wiring.	Contact your installer to remove all connections to the AC load terminals. If Alert persists then your inverter has a stuck contactor and will need a service. Contact Selectronic service at http://www.selectronic.com.au/service/	
Unit - AC Source contactor fault cleared	Above condition has cleared		
Unit - Alarm Silence button fault - button stuck down	Stuck button on the front panel of the inverter. If fault persists contact service	For persistent fault, contact Selectronic service at http://www.selectronic.com.au/service/	
Unit - Control PCA Factory defaults loaded	The user has initiated a "Load Defaults" from the front panel of the inverter.		
Unit - Generator button fault - button stuck down	Stuck button on the front panel of the inverter. If fault persists contact service	For persistent fault, contact Selectronic service at http://www.selectronic.com.au/service/	
Unit - Hi DC Voltage Fault	Battery voltage has risen to an abnormally high level. Normally caused by a fault in the battery, the battery wiring or the battery fusing.	Call installer to check for faulty cells in the battery bank or for poor battery connections between cells and between battery bank and SP PRO.	
Unit - Hi DC Voltage Fault cleared	Above condition has cleared		
Unit - Instant Hi DC Voltage Fault	Battery voltage has risen to an abnormally high level. Normally caused by a fault in the battery, the battery wiring or the battery fusing.	Call installer to check for faulty cells in the battery bank or for poor battery connections between cells and between battery bank and SP PRO	
Unit - Instant Hi DC Voltage Fault cleared	Above condition has cleared		
Unit - Instant Low DC Voltage Fault	Battery voltage has dropped to an abnormally low level. Normally caused by a fault in the battery, the battery wiring or the battery fusing.	Call installer to check for faulty cells in the battery bank or for poor battery connections between cells and between battery bank and SP PRO	
Unit - Instant Low DC Voltage Fault cleared	Above condition has cleared		
Unit - Loading Configuration Settings has timed out - retrying	The configuration settings that were sent from SP LINK have taken much longer than expected. Try again	Check communications link from SP LINK to SP PRO inverter. Try the same process with a direct USB connection.	

Alerts and attention required messages	Meaning and diagnostic	Action	Configuration settings>
Unit - Output Capacitor life expired.	Shutdown. No AC output possible.	Contact Selectronic service at http://www.selectronic.com.au/service/	
Unit - Ouput Capacitor life expired cleared	Above condition has cleared		
Unit - Output Mode button fault - button stuck down	Stuck button on the front panel of the inverter. If fault persists contact service	For persistent fault, contact Selectronic service at http://www.selectronic.com.au/service/	
Unit - Power Module - Current Limit Shutdown	Occurs after multiple power module current limits. Inverter will stay shutdown until a reset or power cycle has been performed. Caused by multiple disturbances in the system or installation fault.	Check that the grid supply or generator is stable. If problem persists then contact your installer to check the AC wiring and the quality of either the grid power or the generator supply.	
Unit - Power Module - Current Limit Shutdown Cleared	Above condition has cleared		
Unit - Power Module - Low 14V Shutdown	Hardware Fault within the inverter. Inverter will not run.	For persistent fault, contact Selectronic service at http://www.selectronic.com.au/service/	
Unit - Power Module - Low 14V Shutdown cleared	Above condition has cleared		
Unit - Power Module 1 - Factory defaults loaded	Caused by hardware glitch. If event persists then contact Service.	For persistent fault, contact Selectronic service at http://www.selectronic.com.au/service/	
Unit - Power Module 2 - Factory defaults loaded	Caused by hardware glitch. If event persists then contact Service.	For persistent fault, contact Selectronic service at http://www.selectronic.com.au/service/	
Unit - Power Supply Shutdown	Hardware Fault within the inverter. Inverter will not run.	For persistent fault, contact Selectronic service at http://www.selectronic.com.au/service/	
Unit - Power Supply Shutdown cleared	Above condition has cleared		
Unit - Real Time Clock - Did not interrupt	There is a fault in the inverter's Real Time Clock. Inverter will need a service.	For persistent fault, contact Selectronic service at http://www.selectronic.com.au/service/	
Unit - Real Time Clock - Reading newer time	There is a fault in the inverter's Real Time Clock. Inverter will need a service.	For persistent fault, contact Selectronic service at http://www.selectronic.com.au/service/	
Unit - Real Time Clock - Reading older time	There is a fault in the inverter's Real Time Clock. Inverter will need a service.	For persistent fault, contact Selectronic service at http://www.selectronic.com.au/service/	
Unit - Real Time Clock - Reading same time	There is a fault in the inverter's Real Time Clock. Inverter will need a service.	For persistent fault, contact Selectronic service at http://www.selectronic.com.au/service/	
Unit - Self Test Fault - Auto Zero	Power up Self test fault. Inverter will not start. Inverter hardware fault.	For persistent fault, contact Selectronic service at http://www.selectronic.com.au/service/	
Unit - Self Test Fault cleared - Auto Zero	Above condition has cleared		
Unit - Self Test Fault - Power Module	Inverter failed Power Up self test. There is an inverter fault. Inverter will not start	For persistent fault, contact Selectronic service at http://www.selectronic.com.au/service/	
Unit - Self Test Fault cleared - Power Module	Above condition has cleared		



Alerts and attention required messages	Meaning and diagnostic	Action	Configuration settings>
Unit - Self Test Fault - Real Time Clock	There is a fault in the inverter's Real Time Clock. Inverter will need a service.	For persistent fault, contact Selectronic service at http://www.selectronic.com.au/service/	
Unit - Self Test Fault cleared - Real Time Clock	Above condition has cleared		
Unit - Transformer Temp Fault - sensor reading too high	There is a fault in the inverter's internal temperature reading. Inverter will need a service.	For persistent fault, contact Selectronic service at http://www.selectronic.com.au/service/	
Unit - Transformer Temp Fault cleared - was too high	Above condition has cleared		
Unit - Transformer Temp Fault - sensor reading too low	There is a fault in the inverter's internal temperature reading. Inverter will need a service.	For persistent fault, contact Selectronic service at http://www.selectronic.com.au/service/	
Unit - Transformer Temp Fault cleared - was too low	Above condition has cleared		

Selectronic Australia Pty Ltd
© 2021

Ph +61 3 9727 6600
Fax +61 3 9727 6601

www.selectronic.com.au